



# **BCM50 Telset Administration Guide**

---

## **BCM50 3.0** Business Communications Manager

Document Status: **Standard**

Document Number: **NN40020-604**

Document Version: **02.01**

Date: **August 2007**

## **Copyright © 2007 Nortel Networks, All Rights Reserved**

All rights reserved.

The information in this document is subject to change without notice. The statements, configurations, technical data, and recommendations in this document are believed to be accurate and reliable, but are presented without express or implied warranty. Users must take full responsibility for their applications of any products specified in this document. The information in this document is proprietary to Nortel Networks.

### **Trademarks**

Nortel, the Nortel logo, and the Globemark are trademarks of Nortel Networks.

Microsoft, MS, MS-DOS, Windows, and Windows NT are trademarks of Microsoft Corporation.

All other trademarks and registered trademarks are the property of their respective owners.

---

# Contents

---

<b>Getting started with BCM</b> .....	<b>5</b>
About this guide .....	5
Purpose .....	5
Audience .....	5
Acronyms .....	6
Symbols and conventions used in this guide .....	6
Related publications .....	8
How to get Help .....	8
<b>Administration telset interfaces</b> .....	<b>11</b>
Initial setup telset menus .....	11
Using FEATURE 9*8 for initial configuration .....	12
Logging in to the F9*8 interface .....	12
Entering keycodes and feature settings .....	14
Activating user accounts and changing passwords .....	16
Viewing or entering IP network information .....	16
System restart .....	19
<b>Using the telset configuration interface</b> .....	<b>21</b>
Programming with the telset telephony interface .....	21
User access to the FEATURE**CONFIG interface .....	22
Programming telephones .....	23
Navigating the telset menus .....	23
Top-level menu of the telset telephony configuration tree .....	27
About the FEATURE **CONFIG menu system .....	27
Terminals and Sets .....	28
Lines .....	34
Services .....	36
System speed dials .....	39
Passwords .....	40
Time and Date .....	41
System programming .....	43
Telco features .....	50
Hardware .....	51
Maintenance .....	53
Usage metrics .....	55
<b>Index</b> .....	<b>57</b>



## Getting started with BCM

---

This section contains information on the following topics:

- [“About this guide” on page 5](#)
- [“Audience” on page 5](#)
- [“Acronyms” on page 6](#)
- [“Symbols and conventions used in this guide” on page 6](#)
- [“Related publications” on page 8](#)
- [“How to get Help” on page 8](#)

### About this guide

The *BCM50 Telset Administration Guide* describes how to use the Telset interface to administer your BCM system. The telset configuration is a tool that is used for system configuration if there is no network connection to your BCM50.

### Purpose

The tasks described in the guide relate to the initial setup of the BCM system, and the configuration of telephone sets.

In brief, the information in this guide explains:

- start-up programming
- keycodes and feature settings
- activating user accounts and changing passwords
- viewing and entering IP network information
- programming telephones

### Audience

The *BCM50 Telset Administration Guide* is directed to network administrators responsible for maintaining BCM50 networks. This guide is also useful for network operations center (NOC) personnel supporting a BCM50 managed services solution. To use this guide, you must:

- be an authorized BCM50 administrator within your organization
- know basic Nortel BCM50 terminology
- be knowledgeable about telephony and IP networking technology

## Acronyms

The following is a list of acronyms used in this guide.

**Table 1** List of acronyms

Acronym	Description
BCM	Business Communications Manager
BRI	Basic Rate Interface
DHCP	Dynamic Host Configuration Protocol
DN	Directory Number
IP	Internet Protocol
ISDN	Integrated Switched Digital Network
NOC	Network Operations Center
ONN	Outgoing Name and Number
PRI	Primary Rate Interface
SM	Silent Monitor

## Symbols and conventions used in this guide

These symbols are used to highlight critical information for the BCM50 system:



**Caution:** Alerts you to conditions where you can damage the equipment.

---



**Danger:** Alerts you to conditions where you can get an electrical shock.

---



**Warning:** Alerts you to conditions where you can cause the system to fail or work improperly.

---



**Note:** A Note alerts you to important information.

---



**Tip:** Alerts you to additional information that can help you perform a task.

---



**Security note:** Indicates a point of system security where a default should be changed, or where the administrator needs to make a decision about the level of security required for the system.



**Warning:** Alerts you to ground yourself with an antistatic grounding strap before performing the maintenance procedure.



**Warning:** Alerts you to remove the BCM50 main unit and expansion unit power cords from the ac outlet before performing any maintenance procedure.

These conventions and symbols are used to represent the Business Series Terminal display and dialpad.

Convention	Example	Used for
Word in a special font (shown in the top line of the display)	<code>Pswd:</code>	Command line prompts on display telephones.
Underlined word in capital letters (shown in the bottom line of a two line display telephone)	<u>PLAY</u>	Display option. Available on two line display telephones. Press the button directly below the option on the display to proceed.
Dialpad buttons	#	Buttons you press on the dialpad to select a particular option.

These text conventions are used in this guide to indicate the information described:

Convention	Description
<b>bold Courier text</b>	Indicates command names and options and text that you need to enter. Example: Use the <b>info</b> command. Example: Enter <b>show ip {alerts   routes}</b> .
<i>italic text</i>	Indicates book titles
plain Courier text	Indicates command syntax and system output (for example, prompts and system messages). Example: Set Trap Monitor Filters
<b>FEATURE HOLD RELEASE</b>	Indicates that you press the button with the coordinating icon on whichever set you are using.

## Related publications

Related publications are listed below. To locate specific information, you can refer to the *Master Index of BCM50 Library* (NN40020-100).

*Keycode Installation Guide* (NN40010-301)

*CallPilot Telephone Administration Guide* (NN40090-500)

*BCM50 Administration Guide* (NN40020-600)

## How to get Help

This section explains how to get help for Nortel products and services.

### Getting Help from the Nortel Web site

The best way to get technical support for Nortel products is from the Nortel Technical Support Web site:

<http://www.nortel.com/support>

This site provides quick access to software, documentation, bulletins, and tools to address issues with Nortel products. More specifically, the site enables you to:

- download software, documentation, and product bulletins
- search the Technical Support Web site and the Nortel Knowledge Base for answers to technical issues
- sign up for automatic notification of new software and documentation for Nortel equipment
- open and manage technical support cases

### Getting Help over the phone from a Nortel Solutions Center

If you don't find the information you require on the Nortel Technical Support Web site, and have a Nortel support contract, you can also get help over the phone from a Nortel Solutions Center.

In North America, call 1-800-4NORTEL (1-800-466-7835).

Outside North America, go to the following Web site to obtain the phone number for your region:

<http://www.nortel.com/callus>

### Getting Help from a specialist by using an Express Routing Code

To access some Nortel Technical Solutions Centers, you can use an Express Routing Code (ERC) to quickly route your call to a specialist in your Nortel product or service. To locate the ERC for your product or service, go to:



<http://www.nortel.com/erc>

### **Getting Help through a Nortel distributor or reseller**

If you purchased a service contract for your Nortel product from a distributor or authorized reseller, contact the technical support staff for that distributor or reseller.



## Administration tset interfaces

You can use Business Element Manager or you can use the Tset interface to administer your BCM50 system. The tset configuration is a tool that is used for system configuration if there is no network connection to your BCM50, or for quick configuration changes, such as changing features in a DN record or updating one of the speed dial lists. Administration tset interfaces are accessible only by a user with an Installer level of tset user privileges. These menus are used at initial startup or to make changes to security-sensitive system settings.

- [“Initial setup tset menus” on page 11](#)
- [“Using FEATURE 9\\*8 for initial configuration” on page 12](#)

### Initial setup tset menus

The initial tset menus are used during the initial configuration of your system. The user requires Installer (Administrator) level of password to use these menus.

FEATURE **7763453	(**PROFILE)	should only be run at the initial set up if the Startup profile did not properly set the country profile on your system and the Element Manager is not accessible to perform this task.
FEATURE **3425723	(**DIALPAD)	allows you to change how the system receives Q and Z in the tset interface.
FEATURE **7827887	(**STARTUP)	should only be run at the initial set up if the Startup profile did not set the telephony profile to the correct setting and the Element Manager is not accessible to perform this task. Note that using this interface returns your system to the default state

**Figure 1** Menus for profiles and dialpad function for startup programming

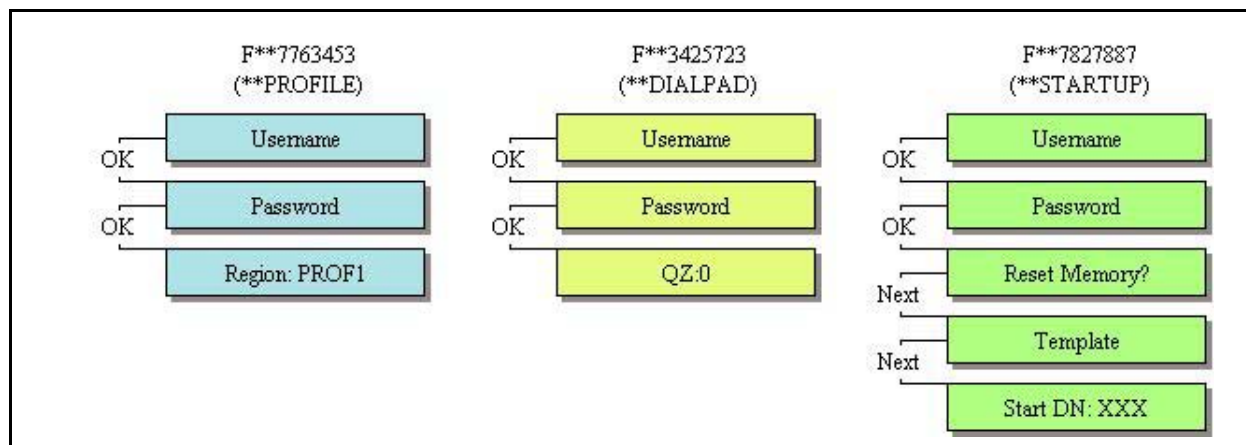

## Using FEATURE 9\*8 for initial configuration

When you log in to the FEATURE 9\*8 interface, it provides access to the following menus:

- Feature Codes: add a keycode for applications such as mail boxes, Fax suite, and private networking. See [“Entering keycodes and feature settings” on page 14](#)
- User Accounts: change user accounts and passwords. See [“Activating user accounts and changing passwords” on page 16](#)
- IP Address: view or set the IP network addressing. See [Viewing or entering IP network information on page 16](#)
- Modem: enable or disable the soft modem. See [“System restart” on page 19](#)
- System Restart: restart your system. See [“System restart” on page 19](#)

## Logging in to the F9\*8 interface

An administration-level telset username and password are required to access this interface. Use the following user ID and password to access the FEATURE 9\*8 feature:

User ID	SETNNA (738662)
Password	CONFIG (266344)

For more information about accessing the telset interfaces, and about which telephones can be used to access the interface, refer to [“Using the telset configuration interface” on page 21](#). Note that this interface does not use the keypad directional arrows that are used for the telephony interface, but rather follows the conventions of the CallPilot F983 interface, which uses display prompts to navigate through the menus.

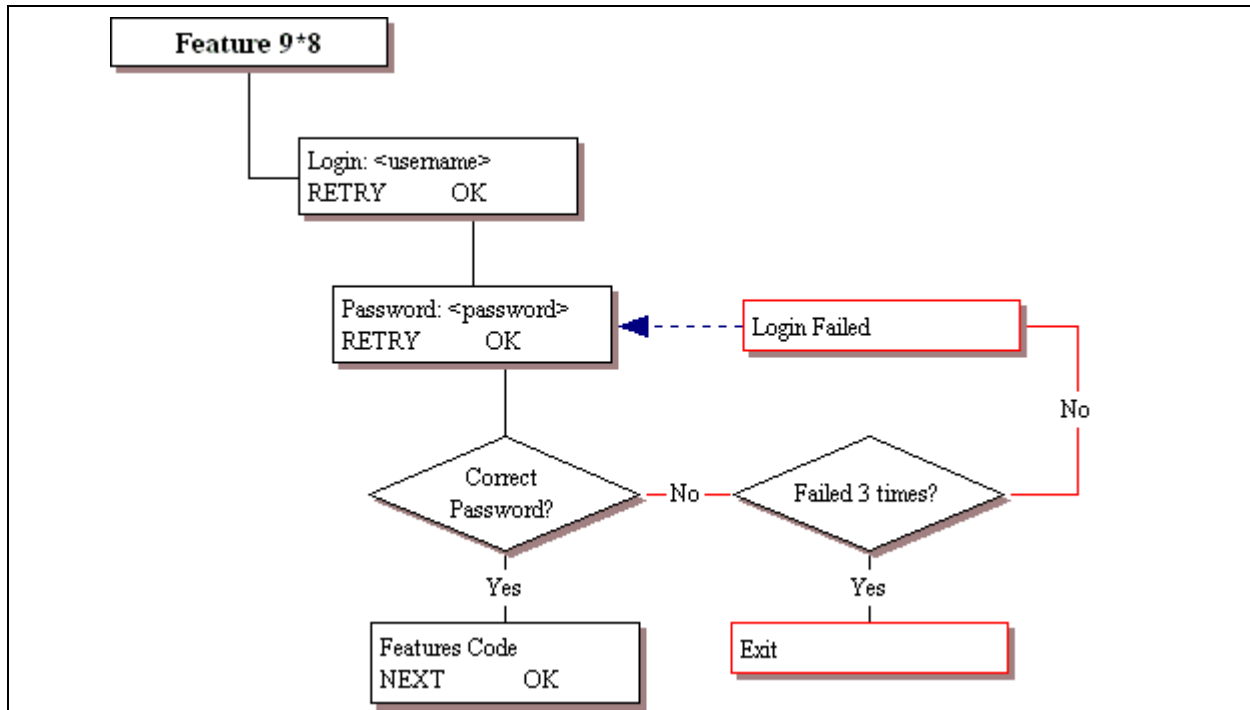
**Figure 2** Log in menu

When a user enters an incorrect password, the system provides a display indicating that there is an entry error. If the user tries repeatedly to enter an invalid username or password, the system locks the user account. The user can wait until the lockout timer releases the account, or the account can be released through this telset menu by a user with administration privileges or through the Element Manager by a user with administration privileges. The lockout timer and the lockout release can be configured in the Element Manager.

## Entering keycodes and feature settings

Features List provides a list of applications that have applied keycodes in the system. When you add applications or increase a feature capacity, you can make those adjustments through this menu. For details about keycodes, refer to the *Keycode Installation Guide* (NN40010-301).

[Figure 3](#) shows the layout for Features List.

Figure 3 Accessing the Features List

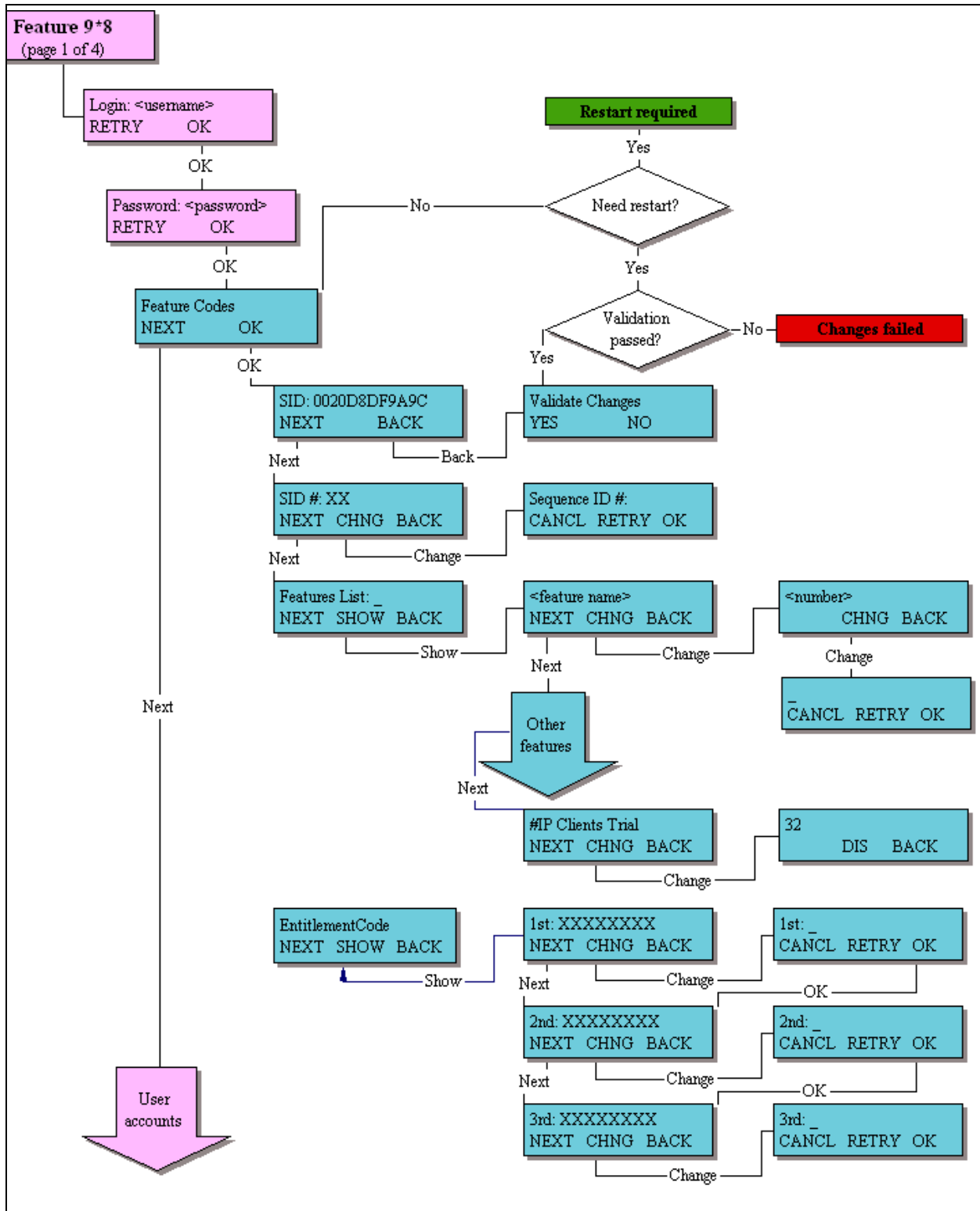

## Activating user accounts and changing passwords

User Accounts provides two menus, one to create or delete user accounts and the other to enter new passwords for user accounts. The username and password can each be 16 digits in length.

Figure 4 shows the layout for User Accounts.

Figure 4 Accessing user accounts and passwords

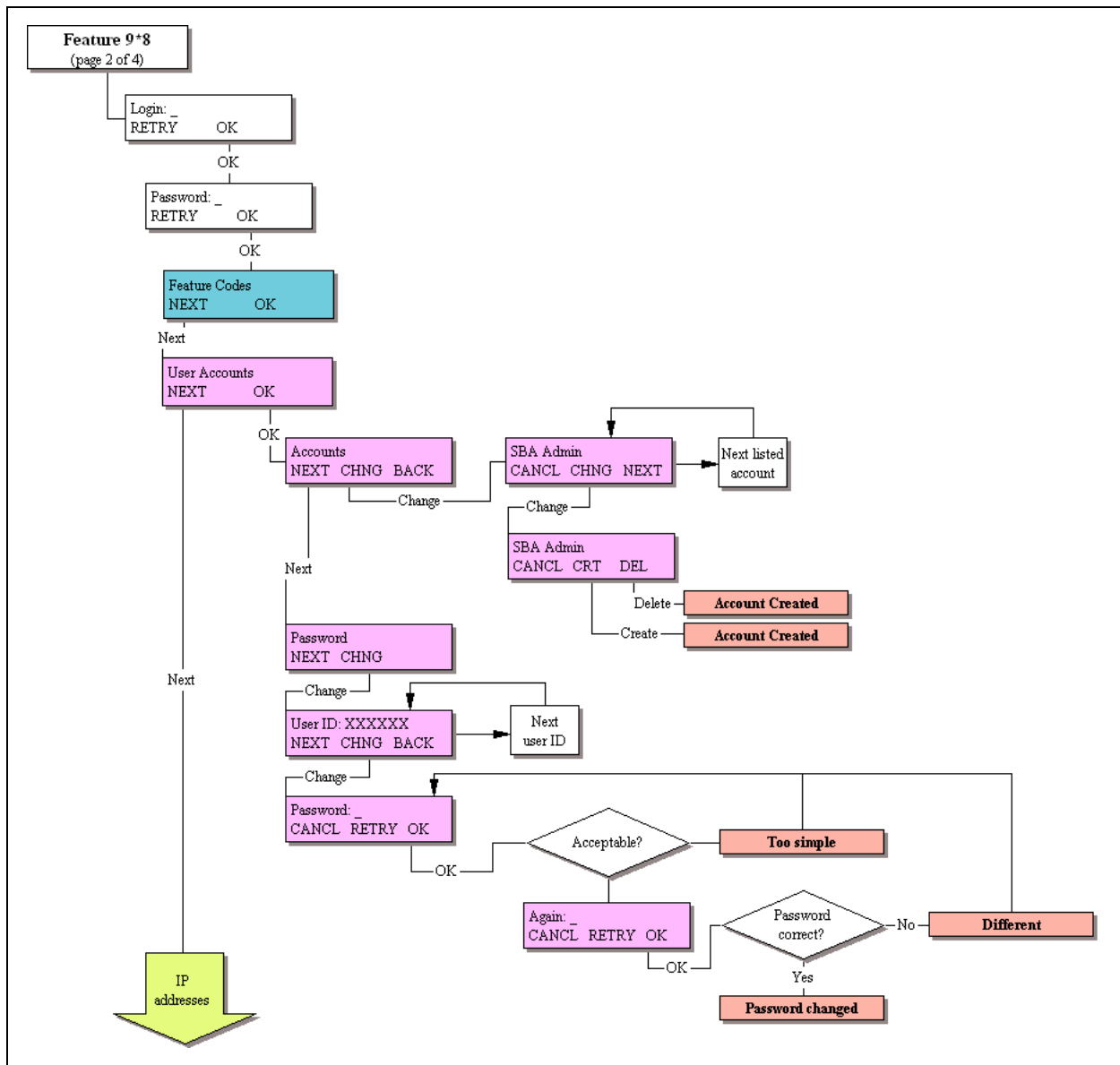

## Viewing or entering IP network information

IP Address allows you to view IP network information on systems where DHCP is enabled. On systems where DHCP is disabled, you can enable DHCP or enter static IP network information.

Figure 5 shows the layout for IP Address.



**Figure 5** Viewing or setting the IP network information

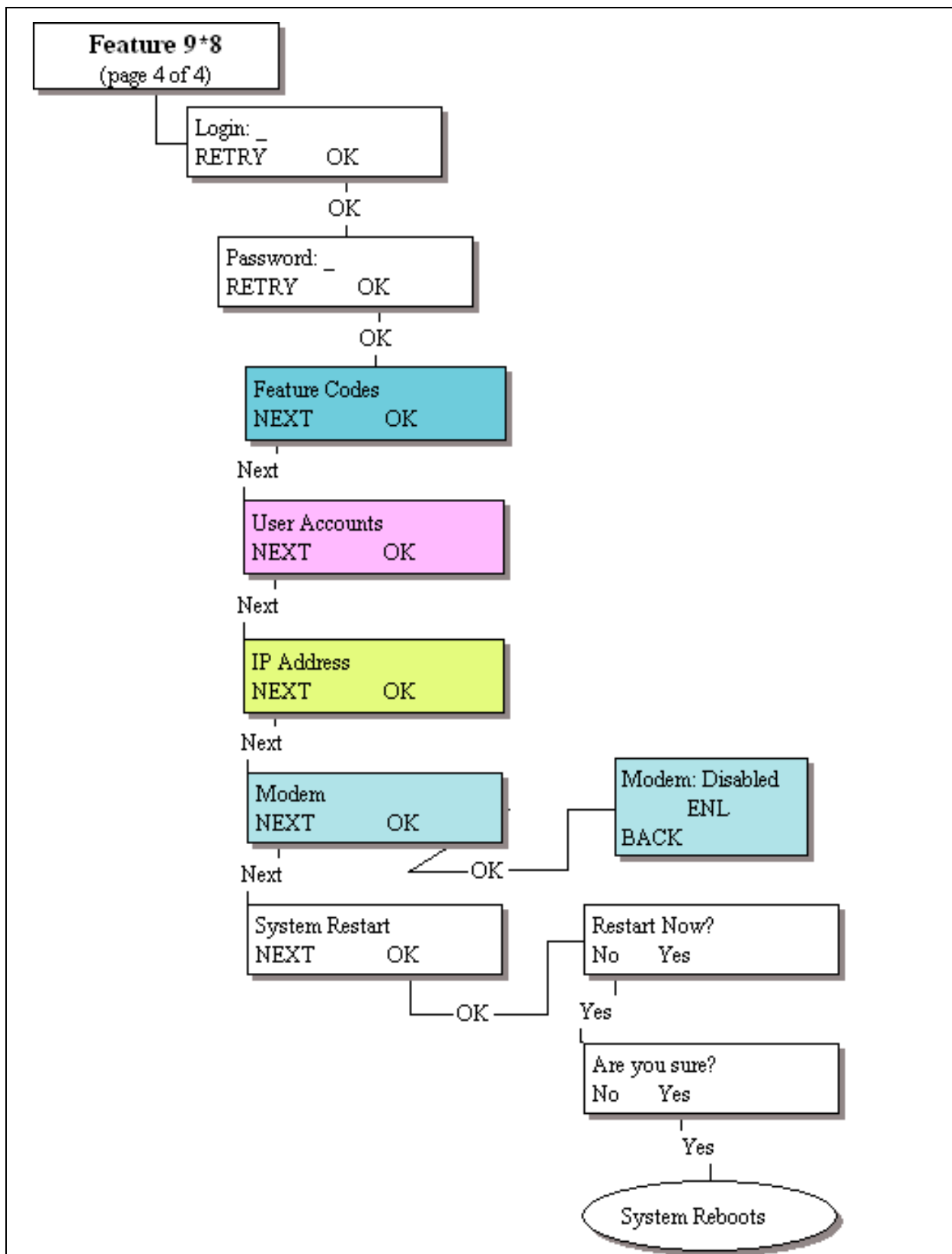

## System restart

The System Restart heading allows you to reboot the BCM50 main unit. Use this when changes you have made indicate that a reboot is required.



**Warning:** Restarting the system interrupts system service.

Figure 6 shows the layout for System Restart.

**Figure 6** Restarting the system

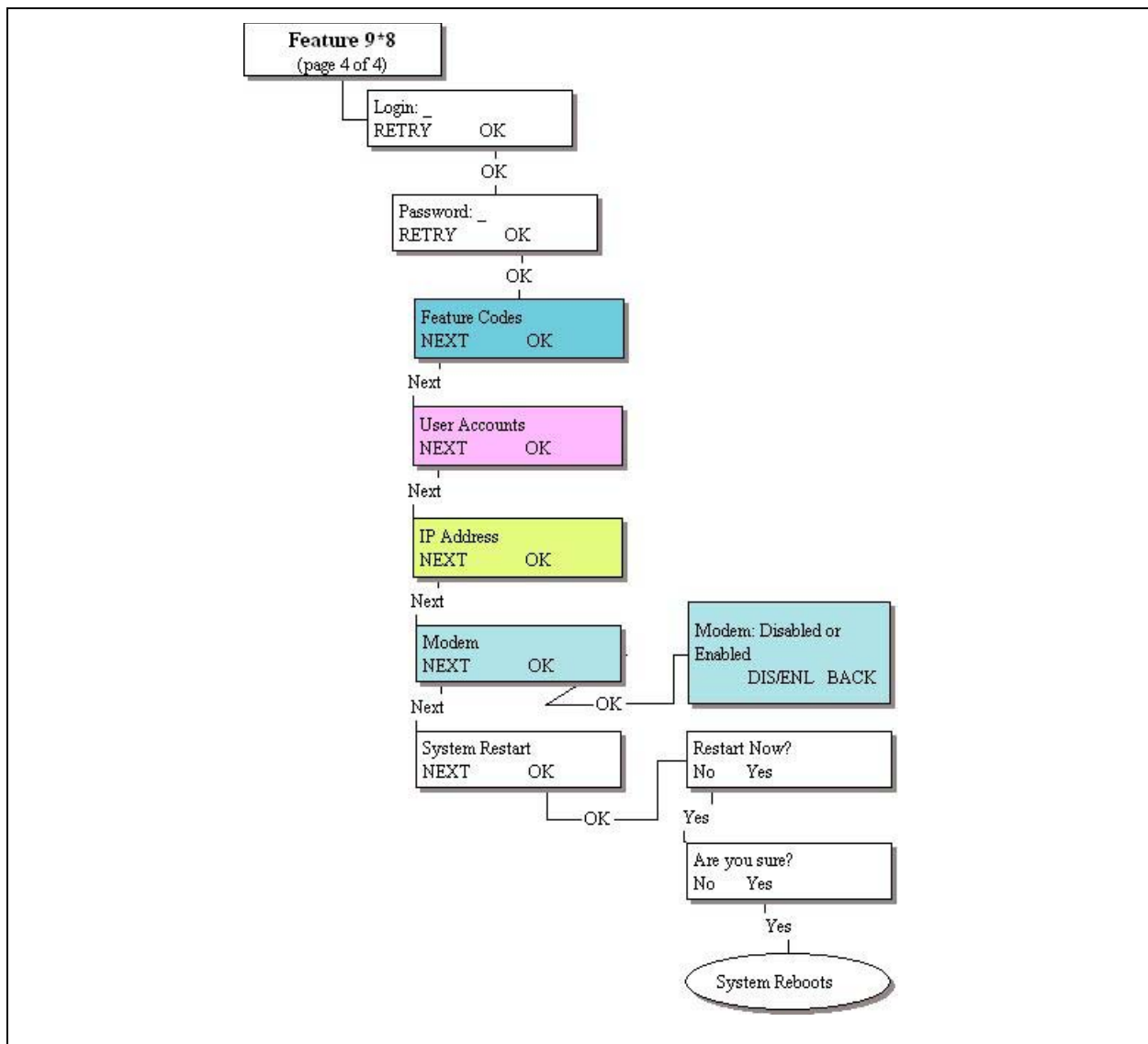



---

## Using the telset configuration interface

---

This section provides maps of the telset configuration menus. The telset configuration is a tool that is used for system configuration if there is no network connection to your BCM50, or for quick configuration changes, such as changing features in a DN record or updating one of the speed dial lists.

Although these menus have most of the features found in the Element Manager user interface, they are not necessarily in the same location. The goal of this section is to help you quickly locate feature programming within the telset configuration menus.



**Note:** For telset administration for CallPilot Vmail via F983, see the *Call Pilot Telephone Administration Guide* (NN40090-500).

---

## Programming with the telset telephony interface

When your system is installed, your installer, or customer service representative, programs it to work with your telephone lines, with your private network if you have one, and with optional equipment. In some cases, they also can provide customization for your specific office requirements. If your system is connected to an IP network, the Element Manager interface provides the most complete access for system programming and any post-installation adjustments you may want to make.

However, if your system is not connected to an IP network, or if your system administrators do not have access to a computer with the Element Manager installed, you can use the telset configuration interface to program or customize your system settings.

Some settings will need to be updated regularly, because of staff requirements or new business contacts, and it is sometimes easier to make quick changes through this menu rather than through the Element Manager.

There are four ways to use the telset configuration interface to customize and maintain your BCM50 system:

- Initial programming is performed for you by your installer or customer service representative. This establishes how the system interacts with lines, telephones, and other equipment. The user who performs the initial programming also has access to the FEATURE 9\*8 telset configuration menu, which allows access to system administration features.
- Post-installation programming, for example to change how features work for the system, is performed by a user assigned as a system coordinator.
- Post-installation programming for basic configuration changes can be provided to the telset user without exposing the more sensitive programming areas. For example:
  - set user information (FEATURE \*\*user (FEATURE \*\*8737))
  - set the Q and Z on the dialpad (FEATURE \*\*dialpad (FEATURE \*\*3425723))

- Personal programming, to change functions related to how the telephone works, is available to anyone through the Feature button on the telephone.



**Note:** You cannot use Telset to configure IP trunk remote gateways, or to configure Meet-me Conferencing..

---

## User access to the FEATURE\*\*CONFIG interface

User identification and user passwords are required to access the telset configuration menus (FEATURE \*\*CONFIG). Although there are a set of default user IDs and passwords, for security purposes it is recommended strongly that these be changed as part of the initial startup activities. Also, it is recommended that each user has a unique user ID and password. This allows for more accurate usage tracking.

User identification and passwords for the telset interface are defined either in the Element Manager or by using the FEATURE 9\*8 telset administration menu, see [“Using FEATURE 9\\*8 for initial configuration” on page 12](#), which is only accessible to users with administrator (Installer) privileges.

There are four levels of user access for the telset telephony configuration menus. These are described in the [Table 1](#). Refer to the system administration information for the Element Manager for information about assigning these access privilege levels to users. Refer to [“Activating user accounts and changing passwords” on page 16](#) through that interface.

A user with Installer or System coordinator+ privileges can also use the Password heading in this menu to change passwords for each privilege level.

**Table 1** User access privileges

Access privilege levels	Description of access
Installer	Has full access to all telset menus, including FEATURE 9*8.
System coordinator+	Has full access to all telset telephony menus relating to telephony system or device set up.
System coordinator	Has more limited access to telset telephony menus relating to telephony system and device set up. For example, this level of user cannot define trunks.
Basic	Has access limited to changing DN record information.
Debug	

In addition, there are two default telset access passwords for the voicemail and call center telset menus. Refer to the *BCM50 Administration Guide* (NN40020-600) for details.

## Programming telephones

To access and use the telset configuration menus, you require a digital or IP telephone with a two-line display.

Both the 7316E digital phone and the 2004 IP phone, shown in [Figure 7](#), can be used for this purpose.

**Figure 7** Digital phone and IP phone

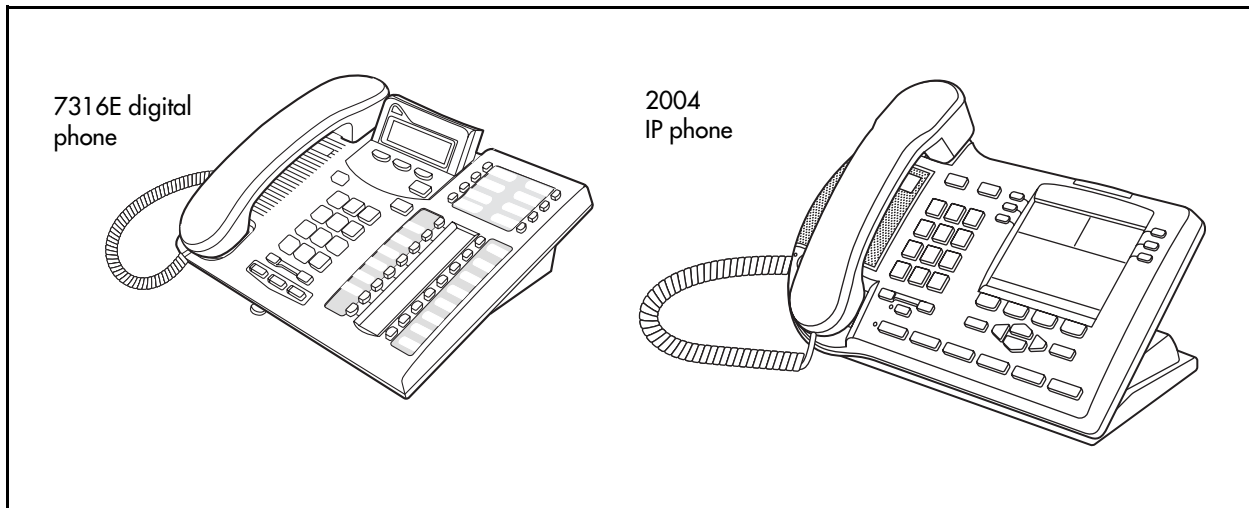

### Navigating the telset menus

Digital and IP phones use slightly different methods of navigating through the telset menus. This section contains the following information:

- [“Using a digital phone to navigate” on page 23](#)
- [“Using an IP phone to navigate the menus” on page 24](#)
- [“What the navigation headings and directions mean” on page 25](#)
- [“Activating menu prompts” on page 25](#)

### Using a digital phone to navigate

When you use a 7316 or 7316E digital phone for telset programming, a group of buttons on the telephone are used to move through programming headings and settings. The programming overlay is used to relabel the four buttons used during programming. The overlay is supplied with each telephone.

**Figure 8** 7316E digital phone with programming overlay

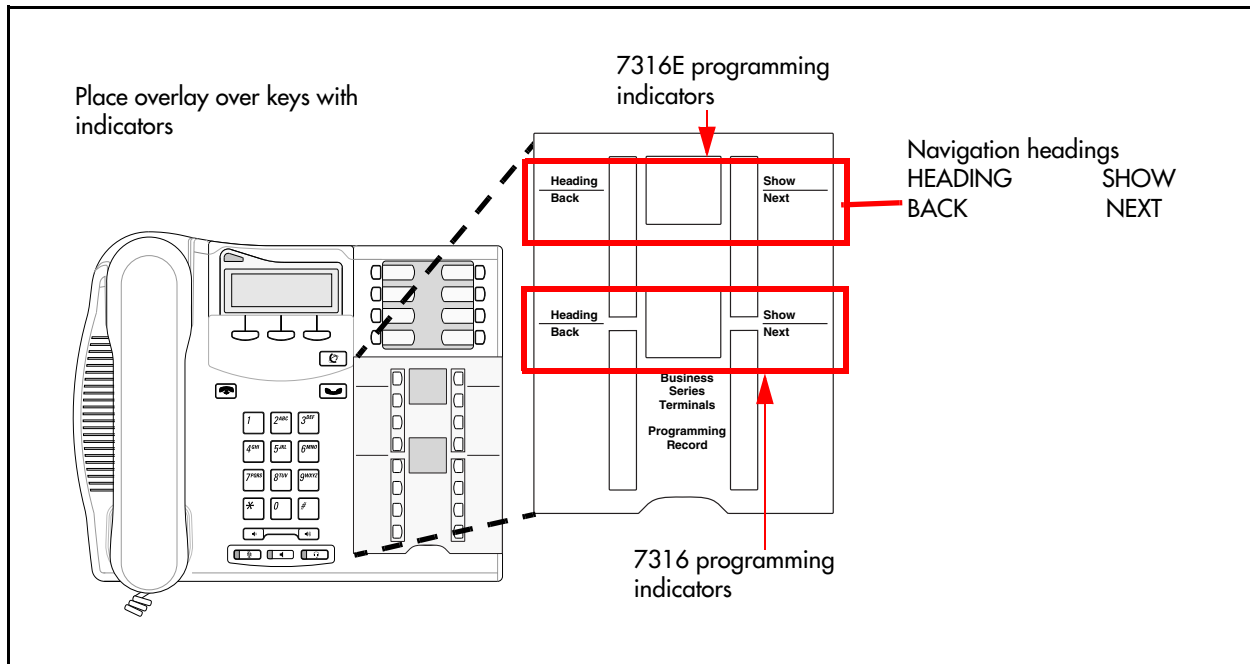

### Using an IP phone to navigate the menus

IP telephones use the telephone directional buttons to move through the menu. The active navigation buttons are shown as a small icon on the far left beside the message prompt.

See [Figure 9](#).

**Figure 9** Display and buttons, IP phone

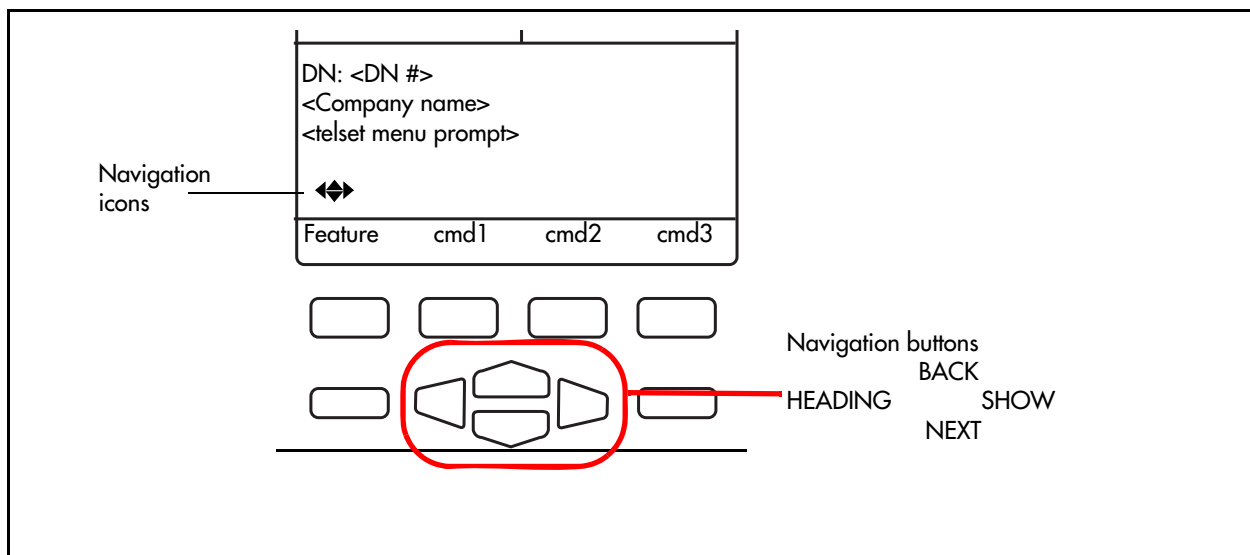



## What the navigation headings and directions mean

Figure 10 shows how the headings on the overlay and the navigational buttons on the IP phone are used to navigate the programming menus.

**Figure 10** How the navigation buttons work

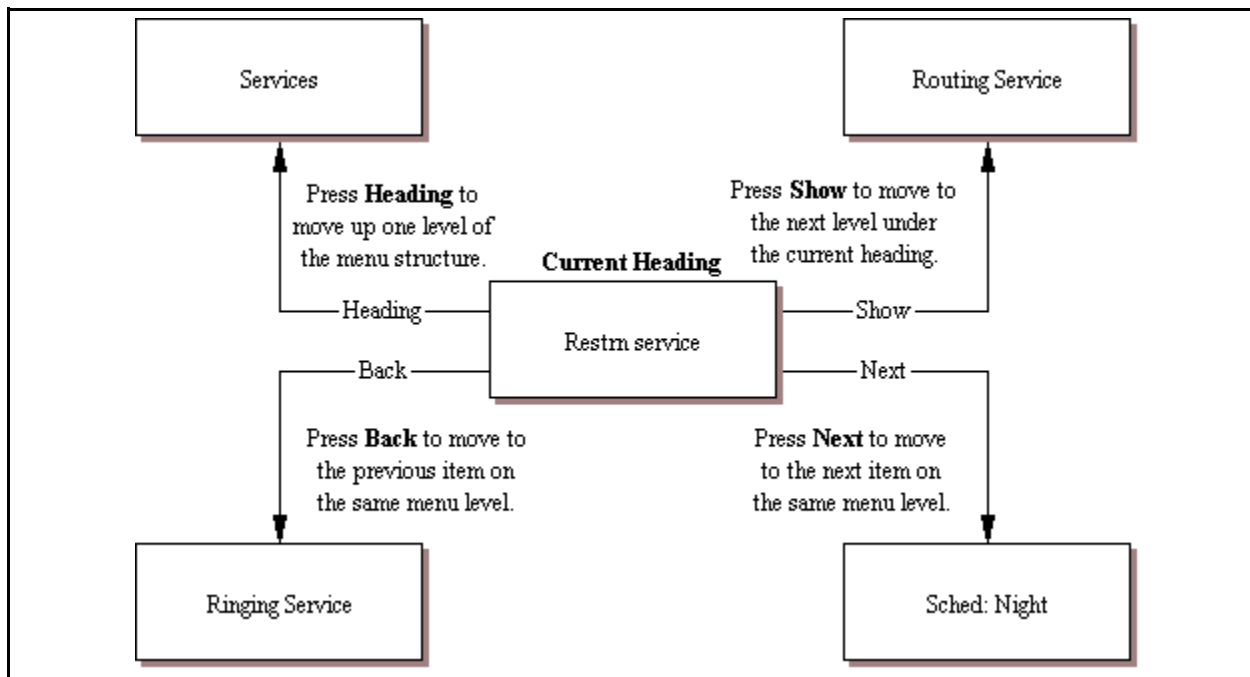

Programming buttons are active or inactive at different stages of programming. On the digital phone, a button is active (meaning you can use that option), when the indicator next to it is lit.

On the IP phone, the navigation icons display the directional arrows that are active.

## Activating menu prompts

Both telephones display the same menu prompts and action prompts that require the user to press the display buttons to perform actions related to the current menu choice. Refer to Figure 11 and Figure 12 for examples of each type of display.

Figure 11 Display and buttons, digital phone

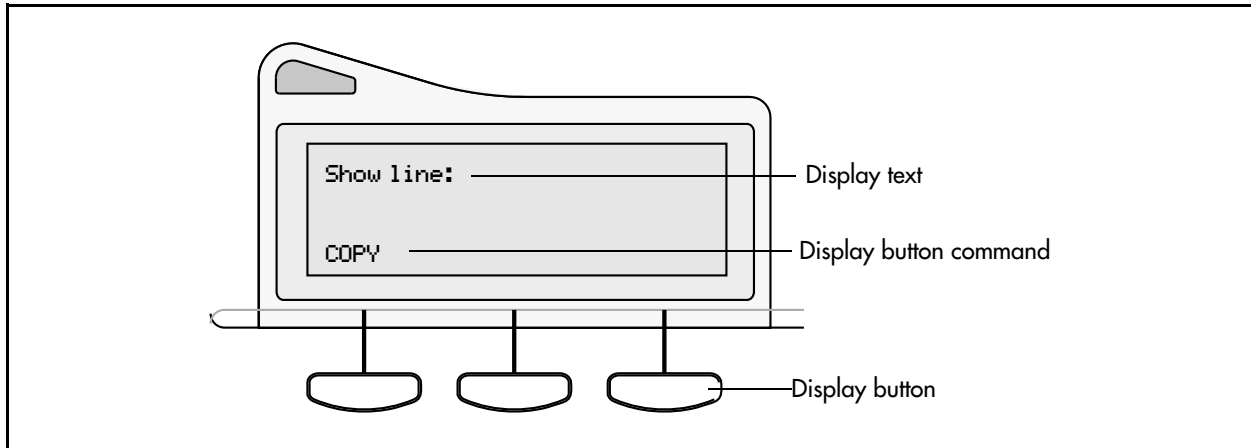
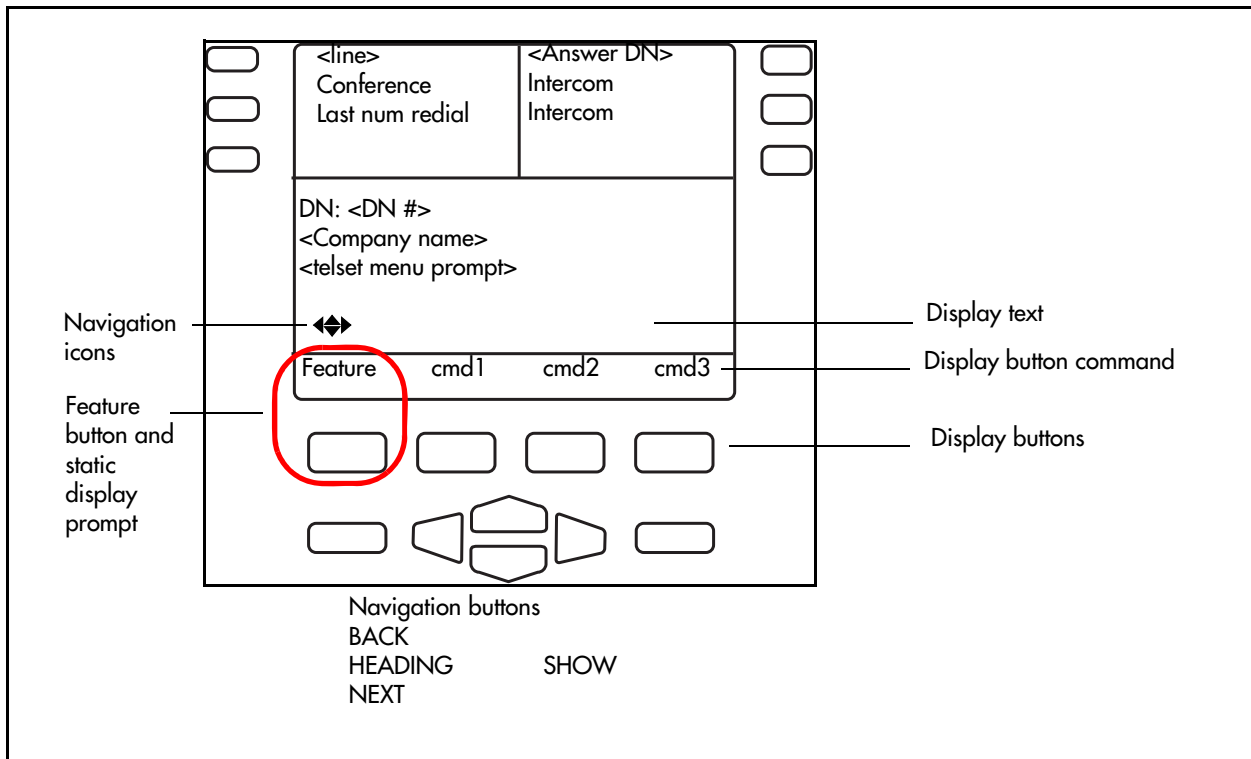

Figure 12 Display and buttons, IP phone



## Top-level menu of the telset telephony configuration tree

Figure 13 describes the contents of each top-level menu on the FEATURE \*\*266344 (\*\*CONFIG) telephony configuration tree. Use the navigation buttons to move through the levels of the tree.

In this section, main headings and their menus are color-coded.

Figure 13 Top-level menus of \*\*CONFIG telset interface

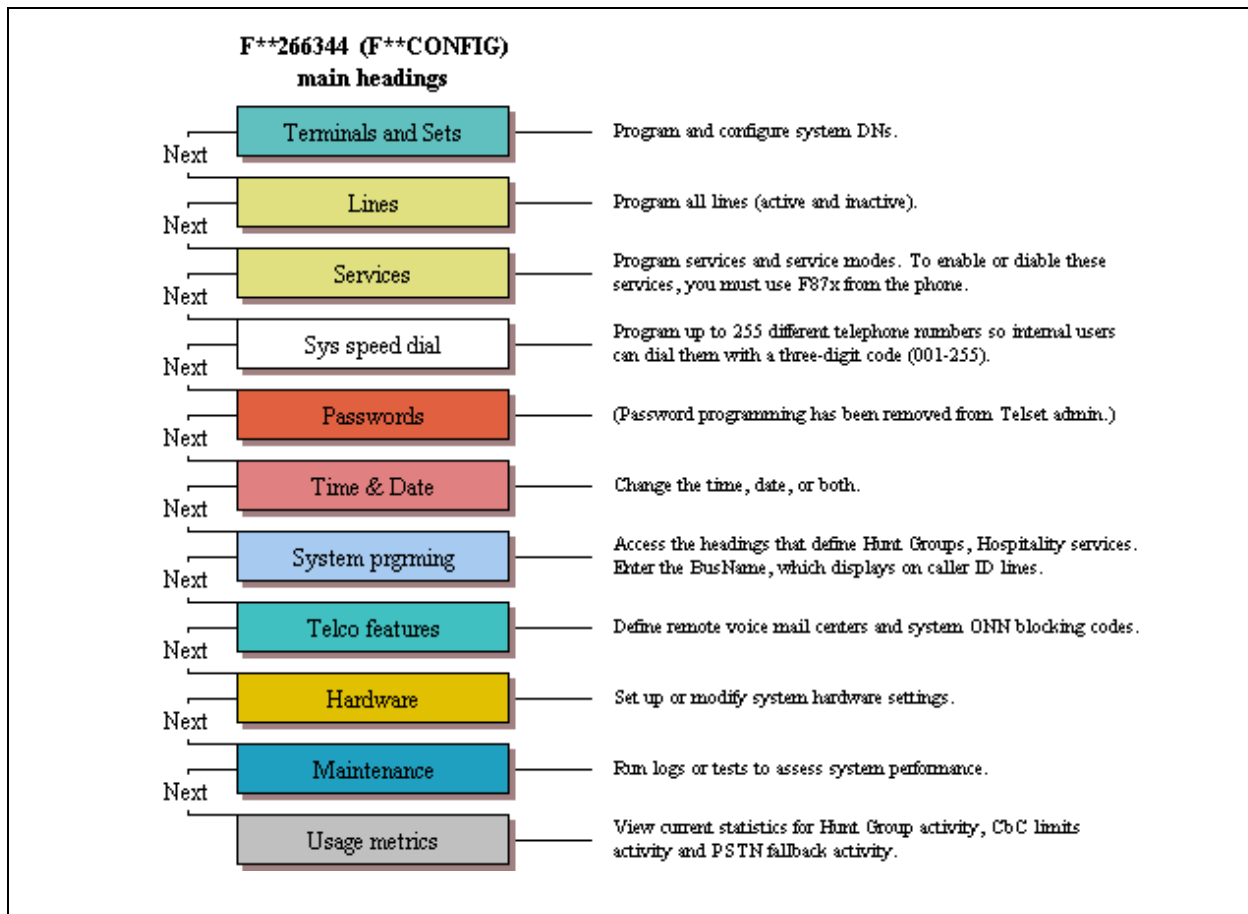

## About the FEATURE \*\*CONFIG menu system

The following pages provide a number of flow charts that show the various levels of the telset configuration tree. Note that the arrows indicate which navigation button is required to move to the next level.

- [“Terminals and Sets” on page 28](#)
- [“Lines” on page 34](#)
- [“Services” on page 36](#)

- [“System speed dials” on page 39](#)
- [“Time and Date” on page 41](#)
- [“System programming” on page 43](#)
- [“Telco features” on page 50](#)
- [“Hardware” on page 51](#)
- [“Maintenance” on page 53](#)
- [“Usage metrics” on page 55](#)

## Terminals and Sets

[Figure 14](#) through [Figure 17](#) show the headings under the **Terminals and Sets** menu. These records are used to set up System DN's for Telephones, and system devices.

Figure 14 Terminals and Sets (Sheet 1 of 4)

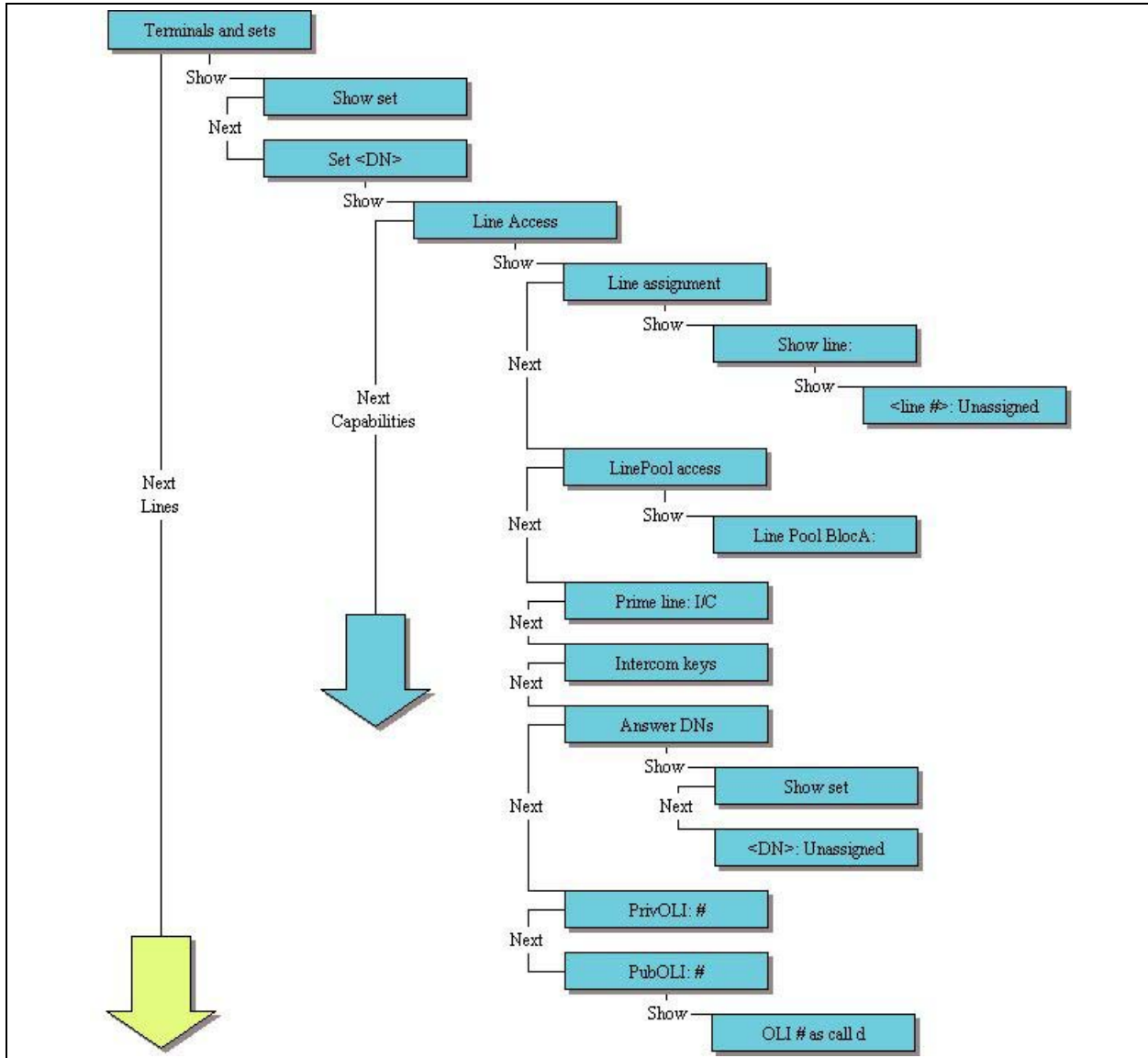

**Figure 15** Terminals and Sets (Sheet 2 of 4)

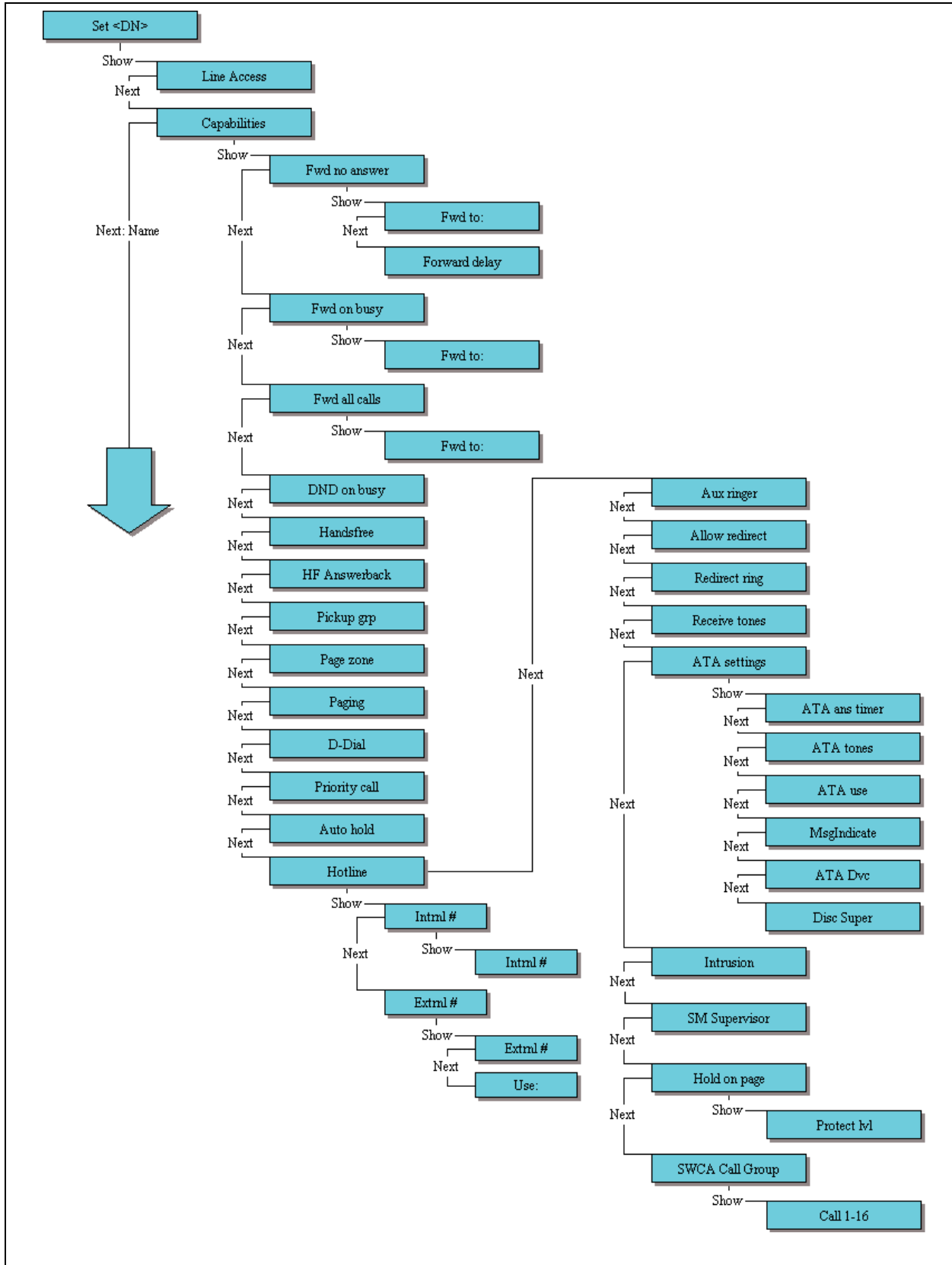

Figure 16 Terminals and Sets (Sheet 3 of 4)

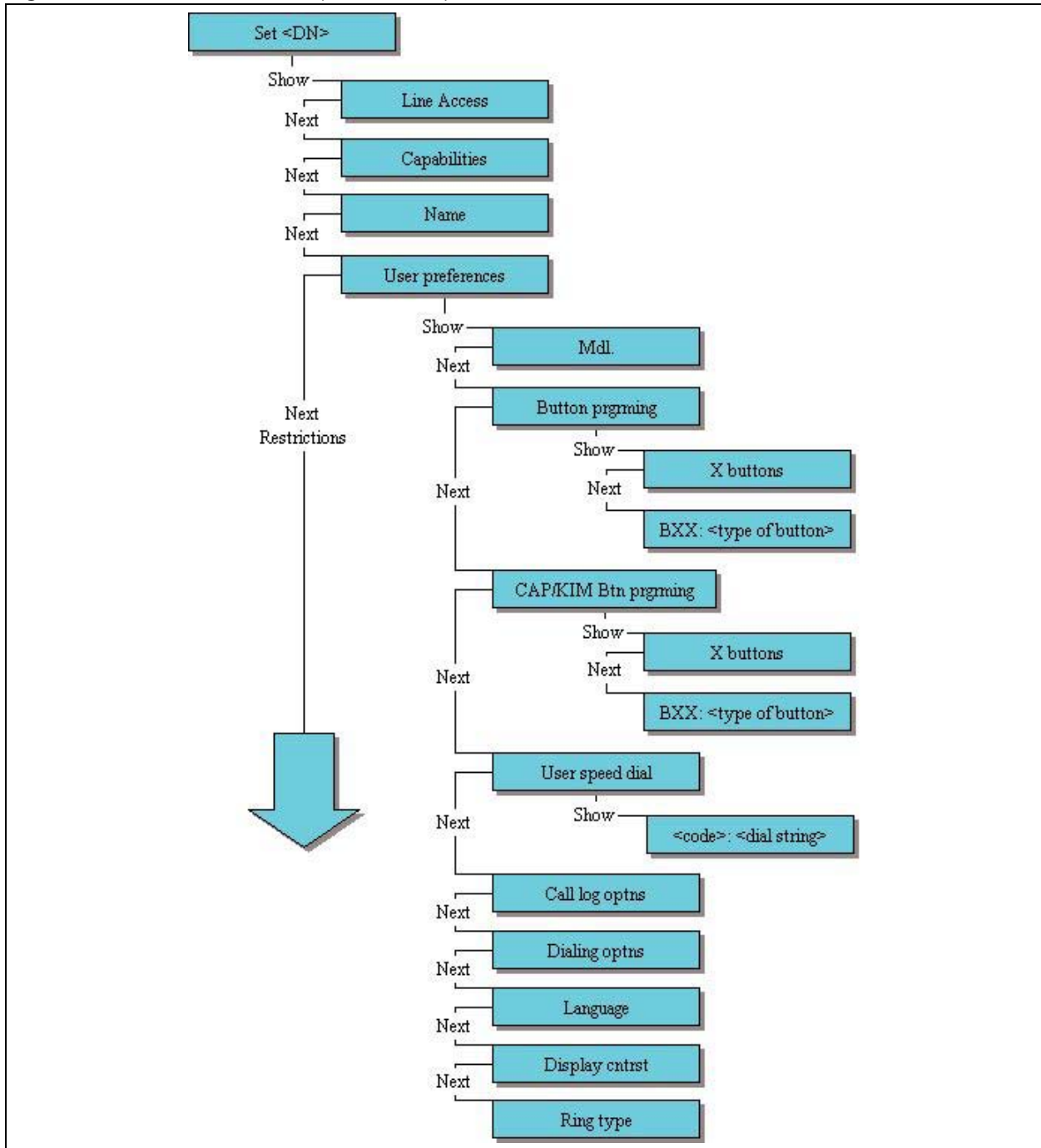
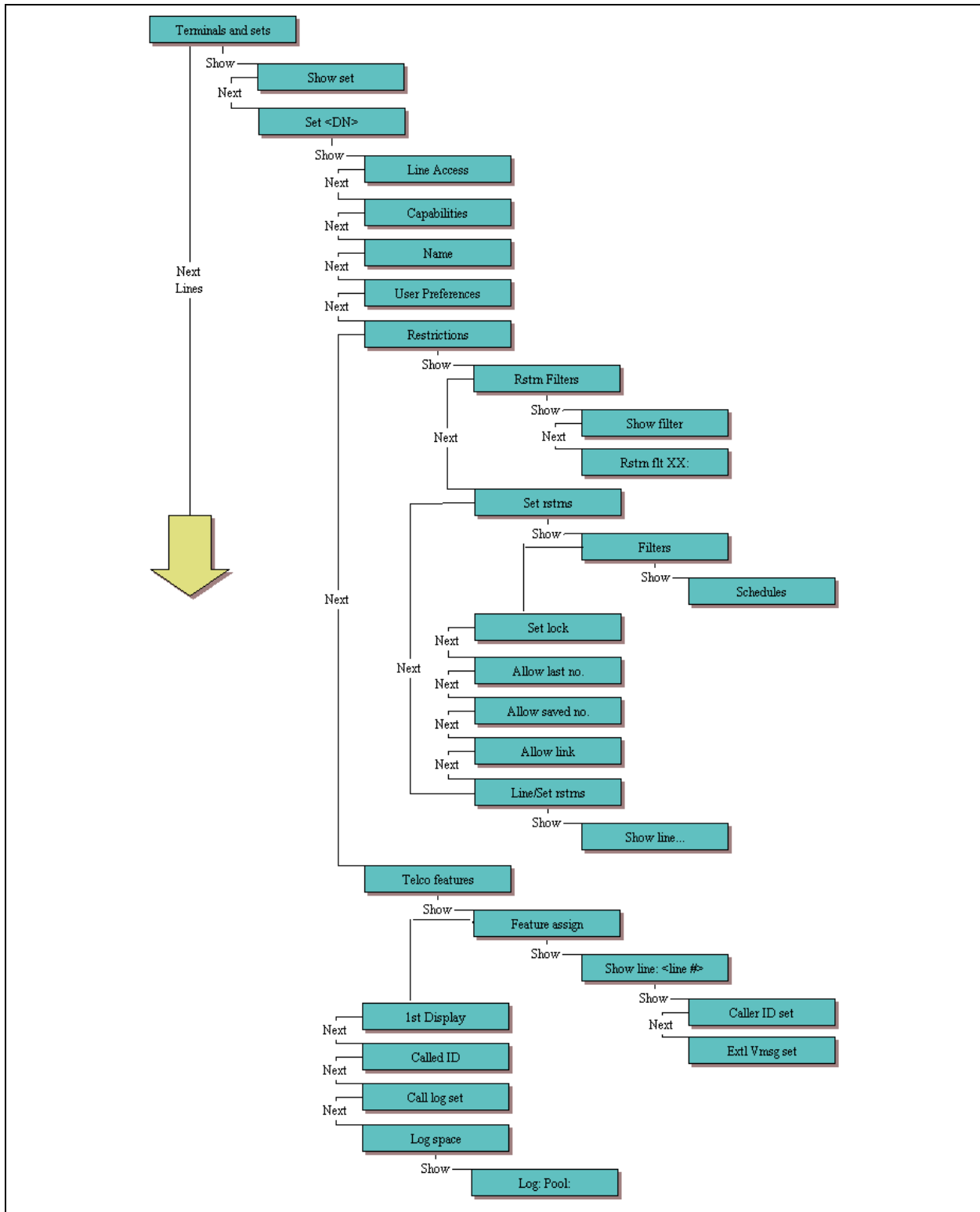



Figure 17 Terminals and Sets (Sheet 4 of 4)



## Lines

Figure 18 and Figure 19 show the headings under the telset interface **Lines** heading. These records are used to set up individual lines that connect to the system from an external source.

Figure 18 Lines (Sheet 1 of 2)

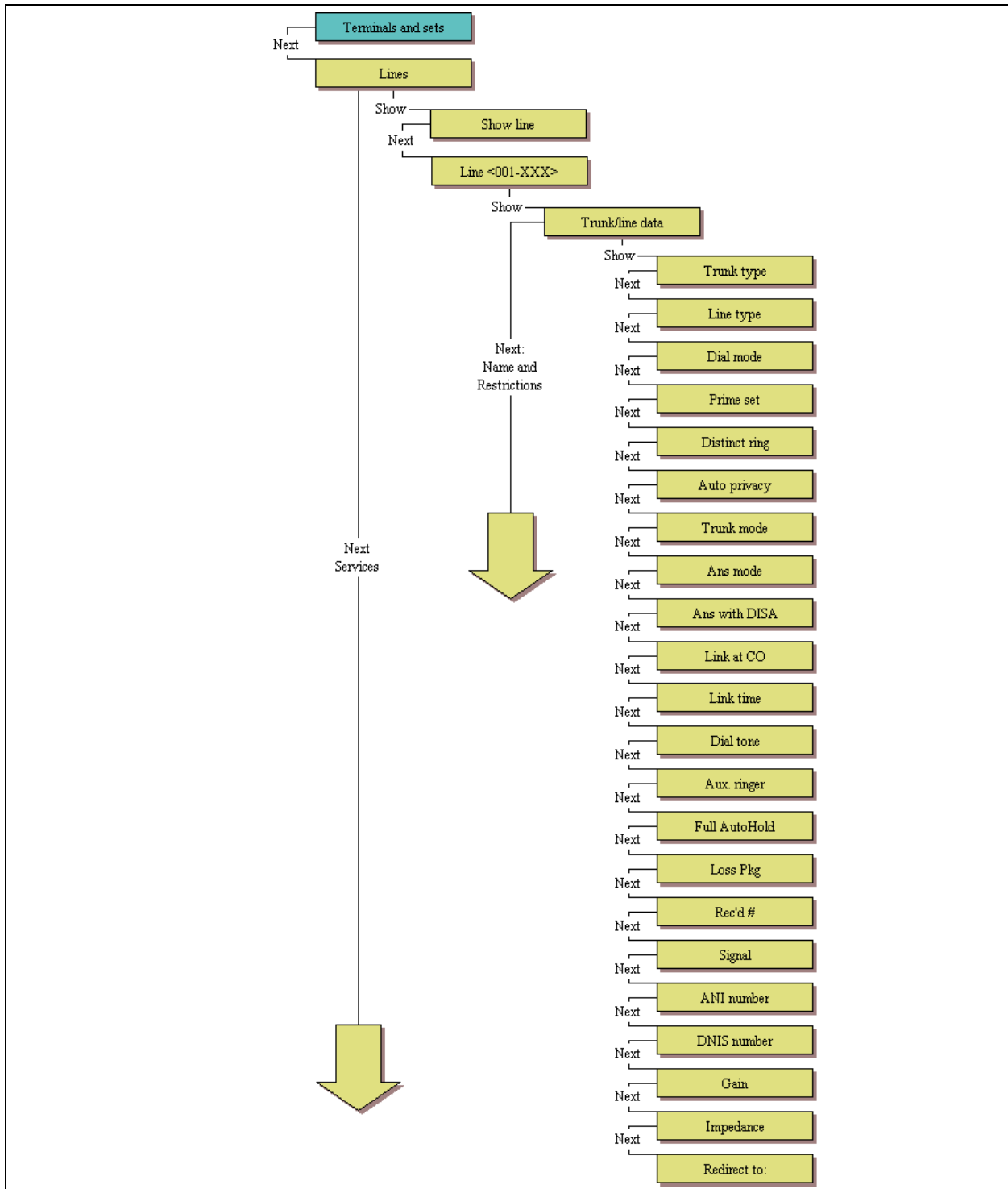

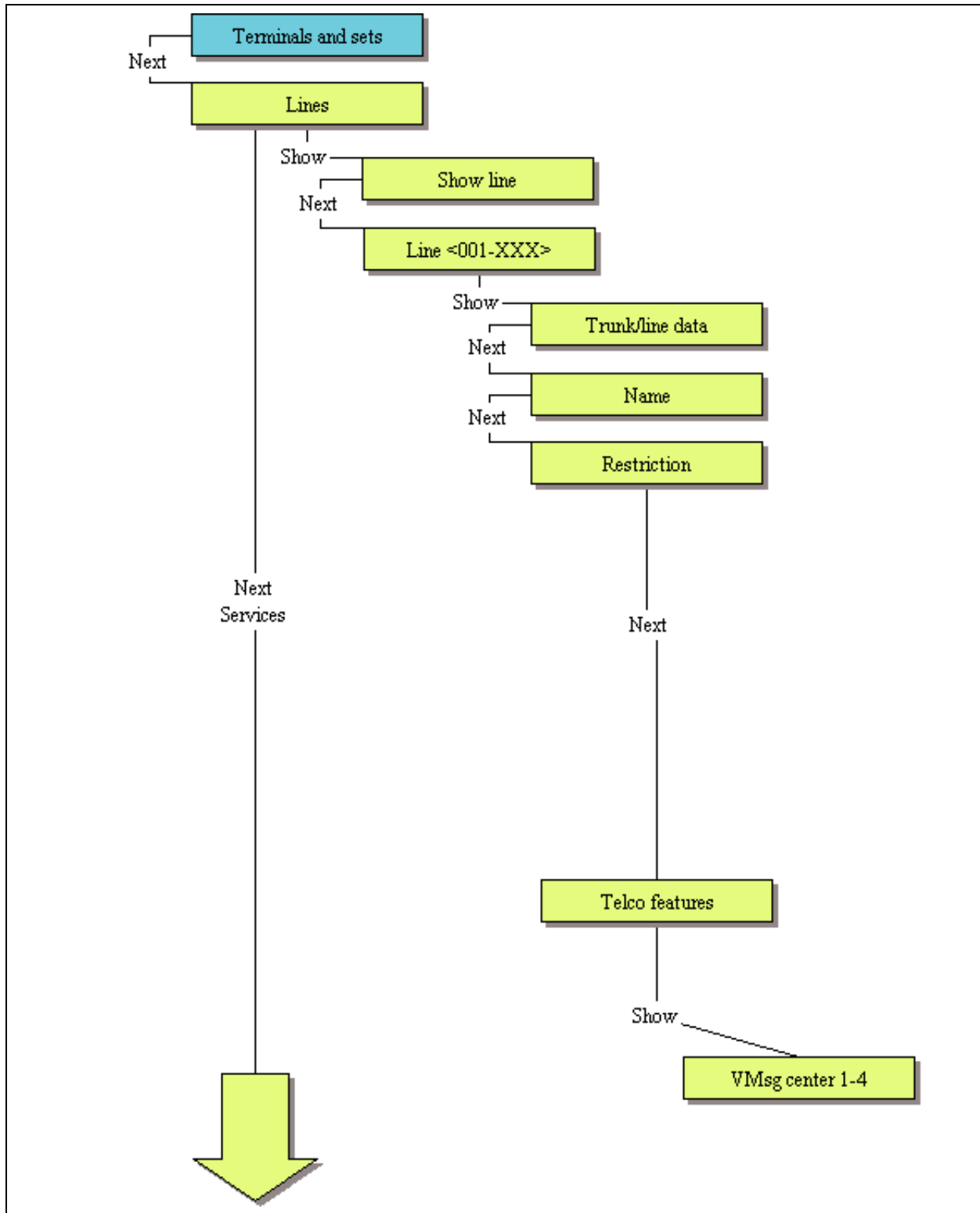
**Figure 19** Lines (Sheet 2 of 2)

## Services

Figure 20, Figure 21 and Figure 22 show the headings under the telset interface **Services** heading. These records are used to set up scheduling for ring groups, restrictions, and routing. The ring groups also are set up under this heading.

Figure 20 Services (Sheet 1 of 3)

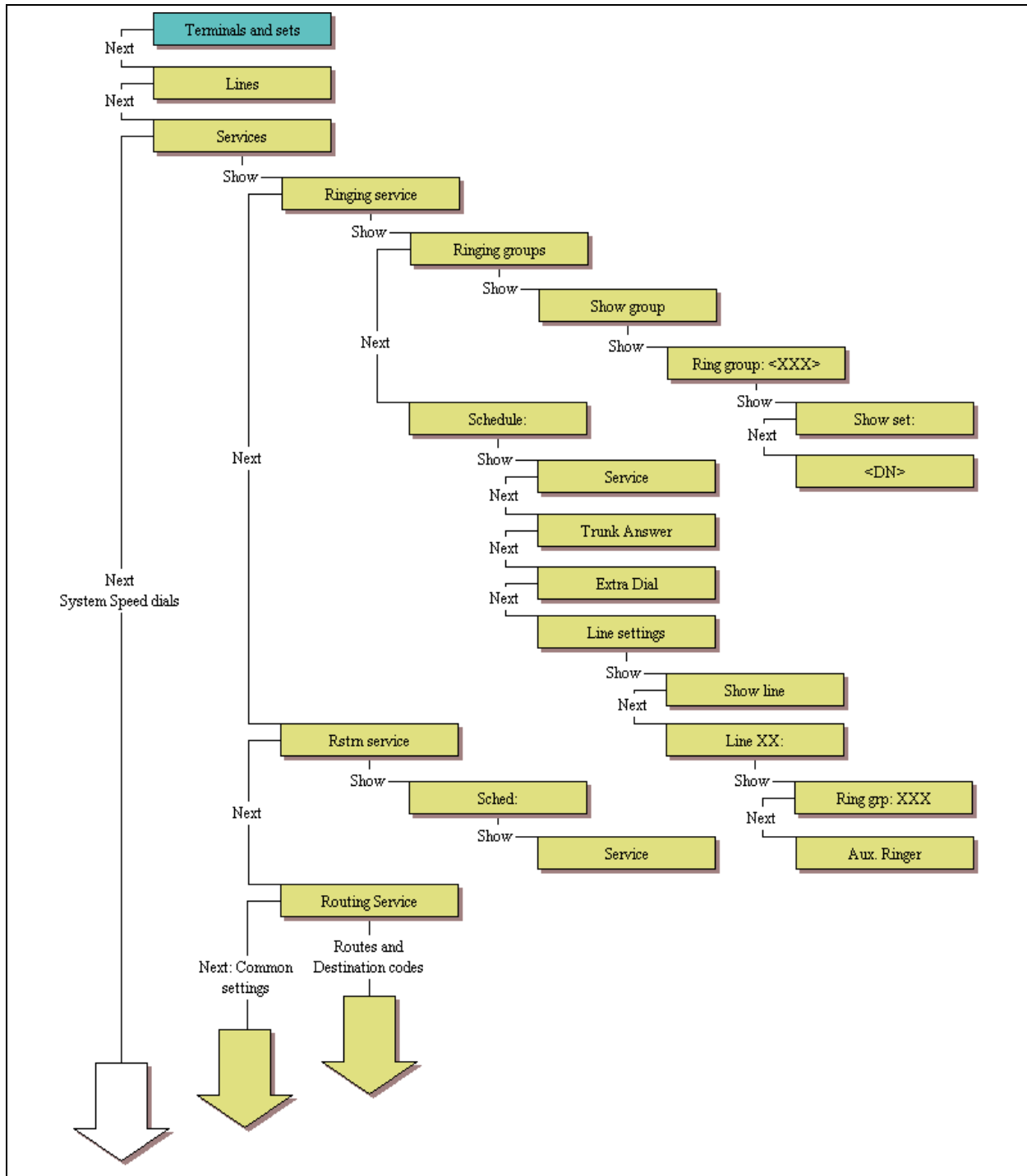

Figure 21 Services (Sheet 2 of 3)

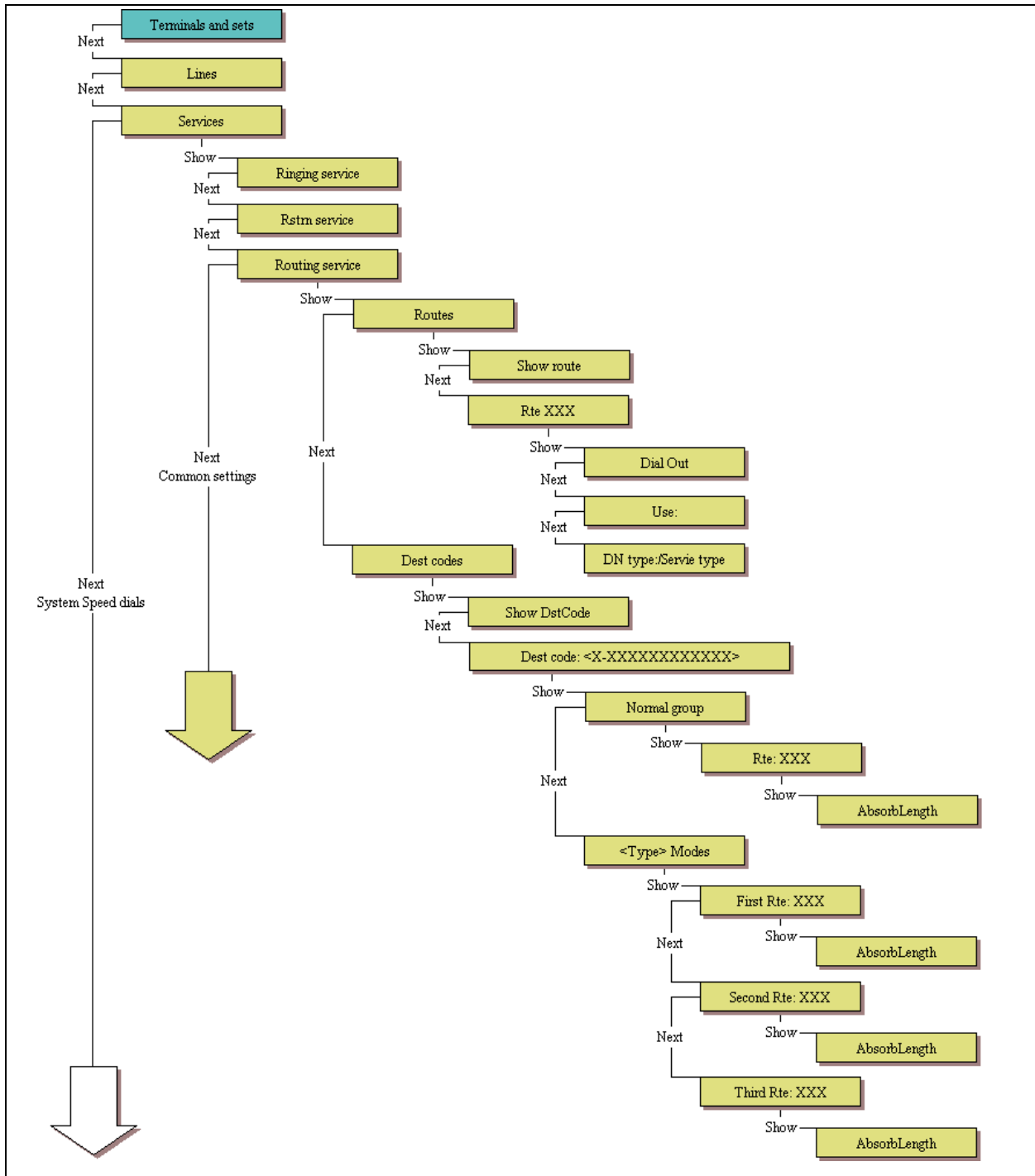
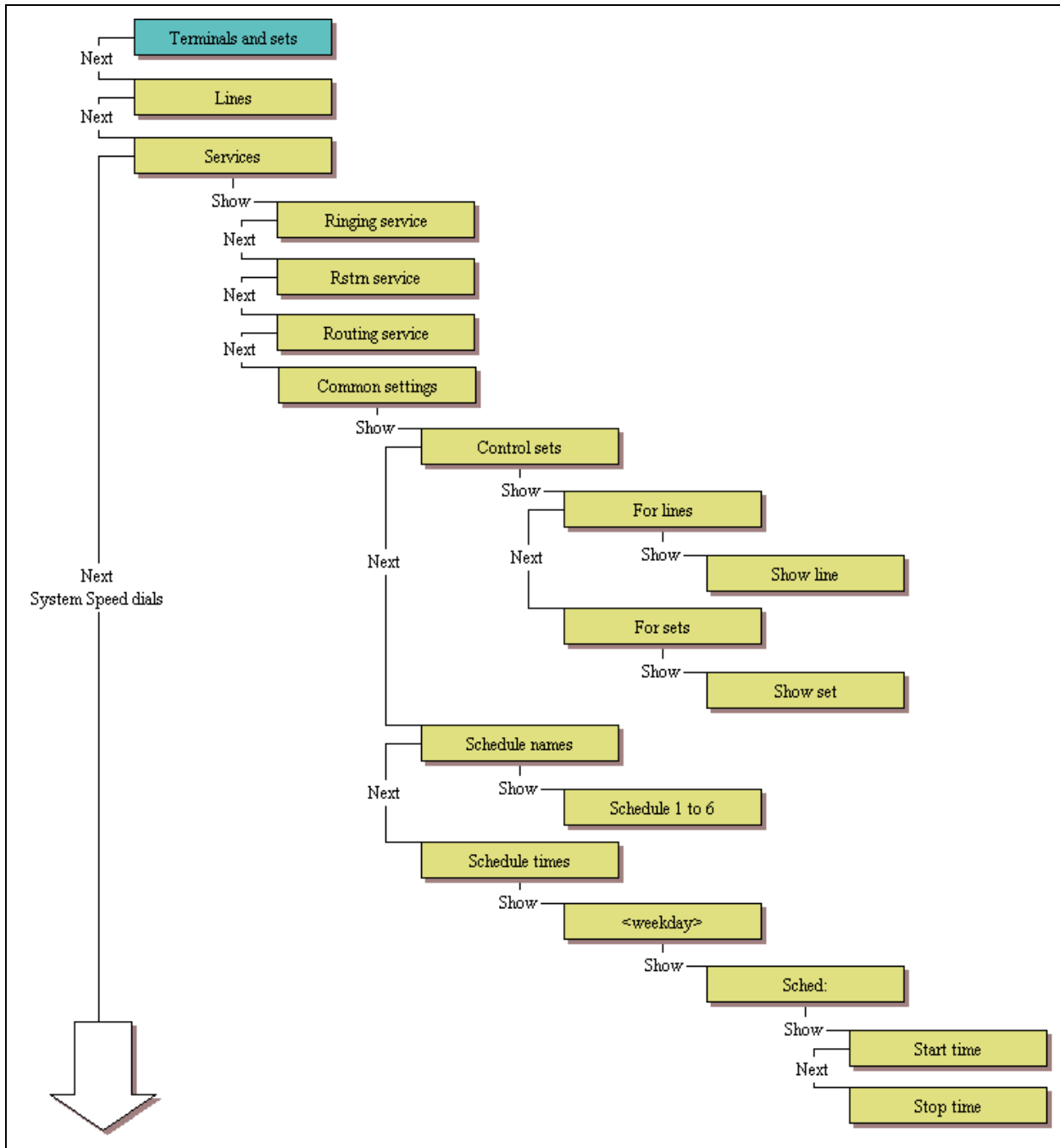

Figure 22 Services (Sheet3 of 3)



## System speed dials

Figure 23 shows the headings under the telset interface **System speed dials** heading. These records are used to set up lists of numbers that are accessed through a two- or three-digit code.

**Figure 23** System speed dials

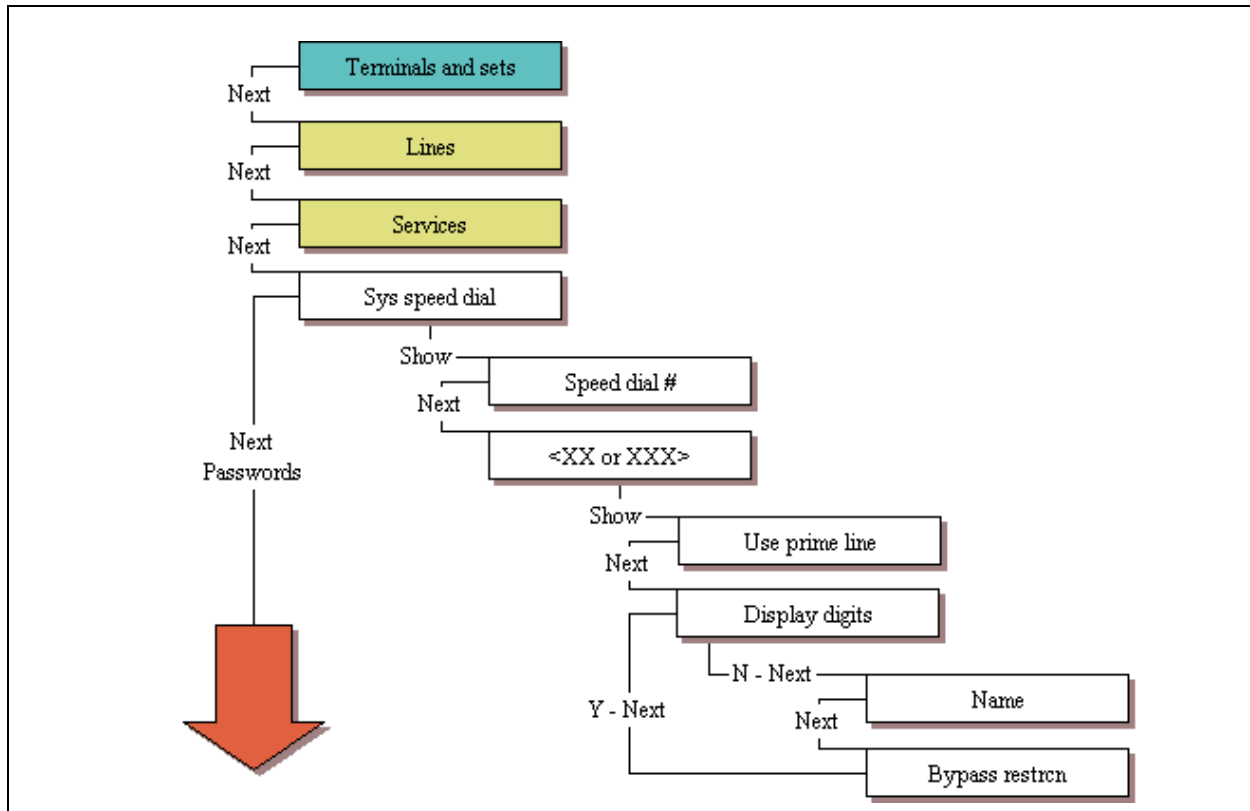

## Passwords

Figure 24 shows the headings under the telset interface **Passwords** heading. These records are used to adjust the passwords for the following system features:

- COS passwords
- Call log passwords
- Hospitality passwords
- SM password



Figure 24 Feature passwords

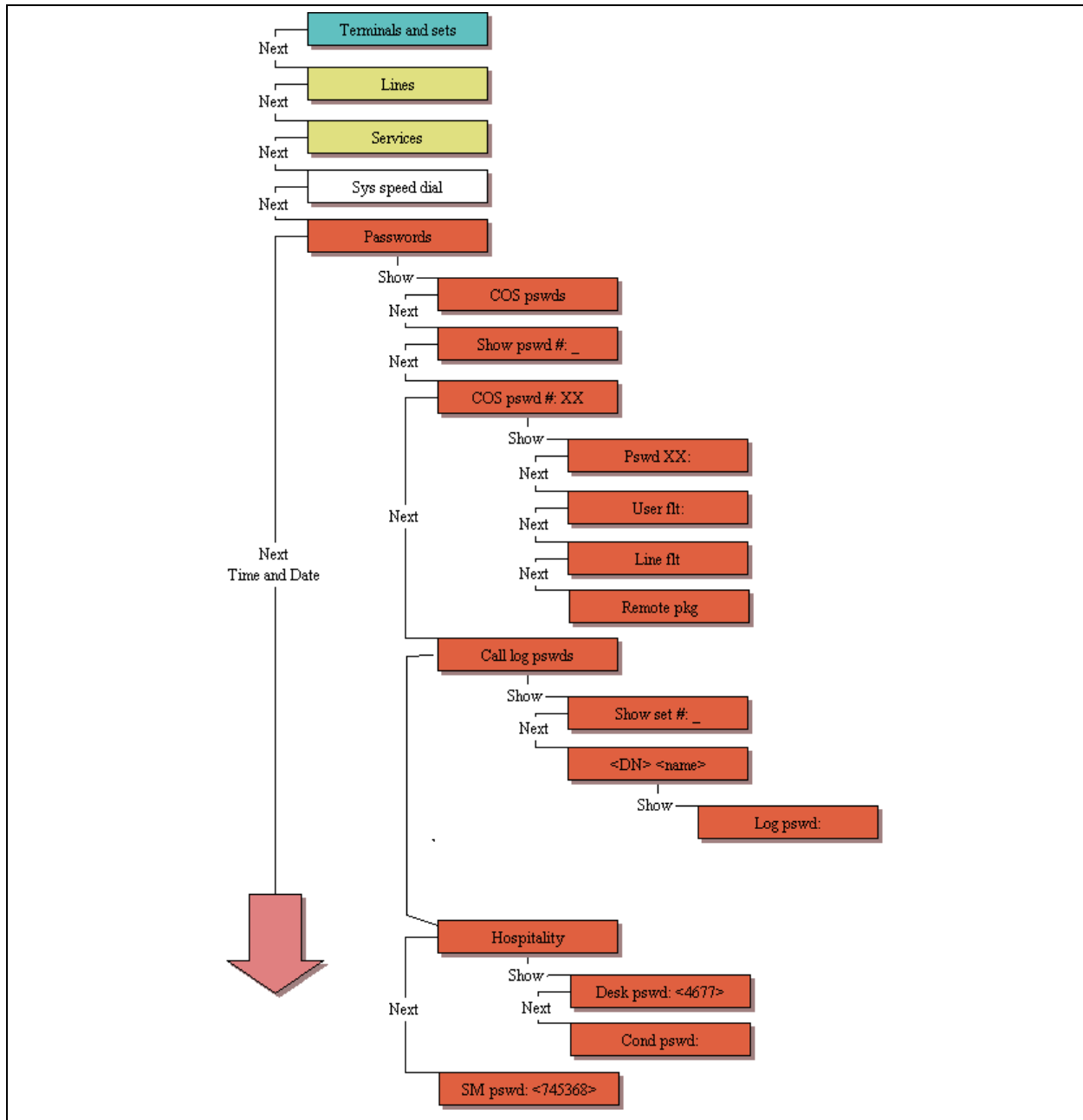

## Time and Date

Figure 25 shows the headings under the telset interface **Time and Date** heading. These records are used to adjust the time and date for the system. This is the time and date that appears on each telephone.

Figure 25 Time and Date

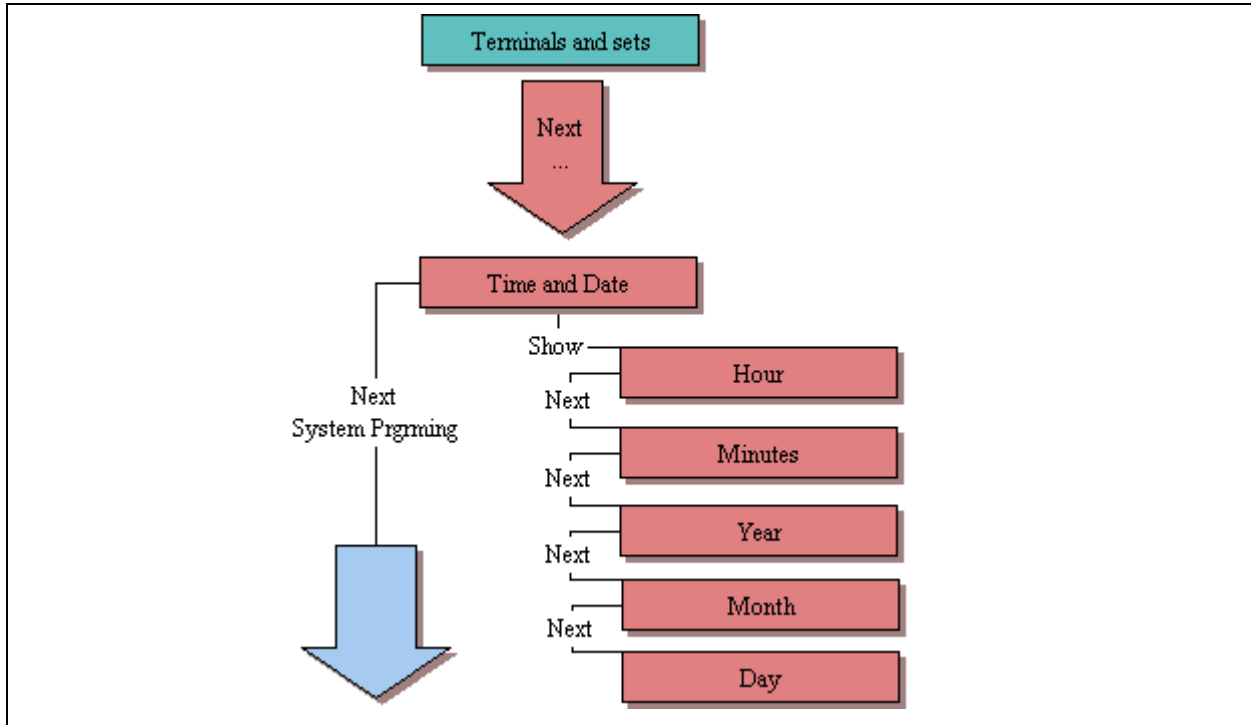

## System programming

Figure 26 through Figure 32 shows the headings under the telset interface **System prgrming** heading. These records are used to program global telephony settings. This includes the special features for Hunt groups and Hospitality services.

Figure 26 System prgming (Sheet 1 of 7)

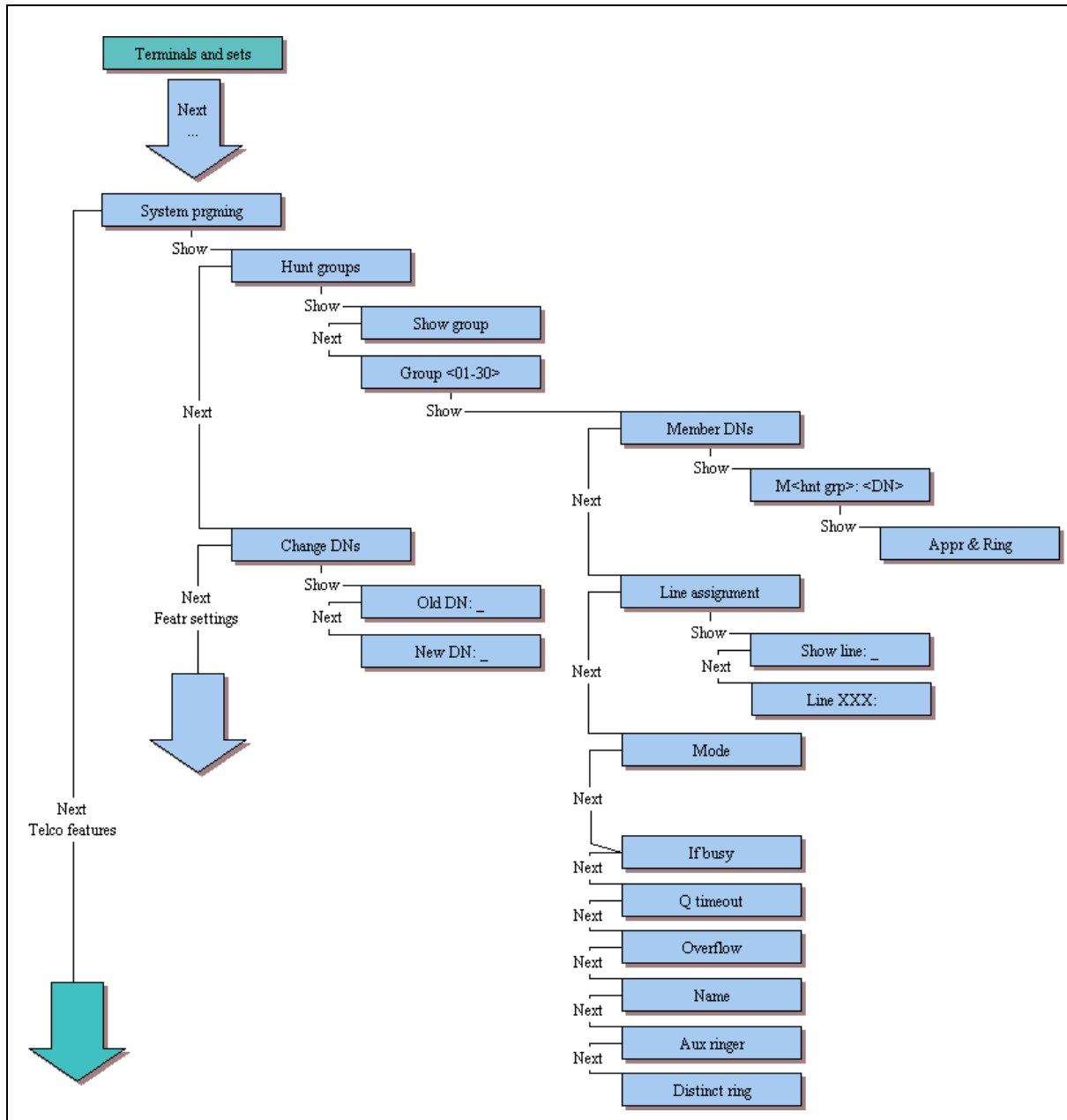

Figure 27 System prgming (Sheet 2 of 7)

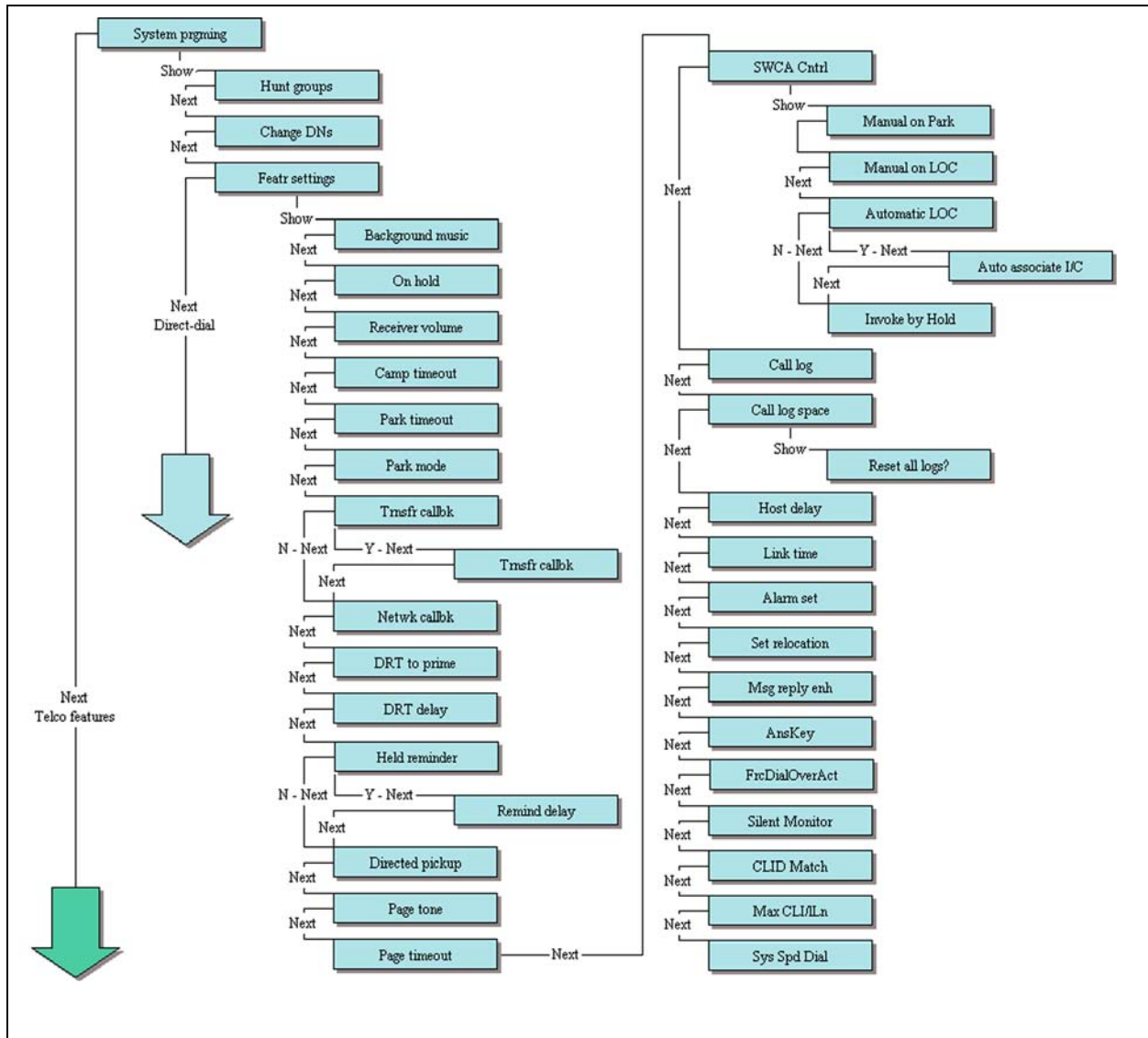

Figure 28 System prgming (page 3 of 7)

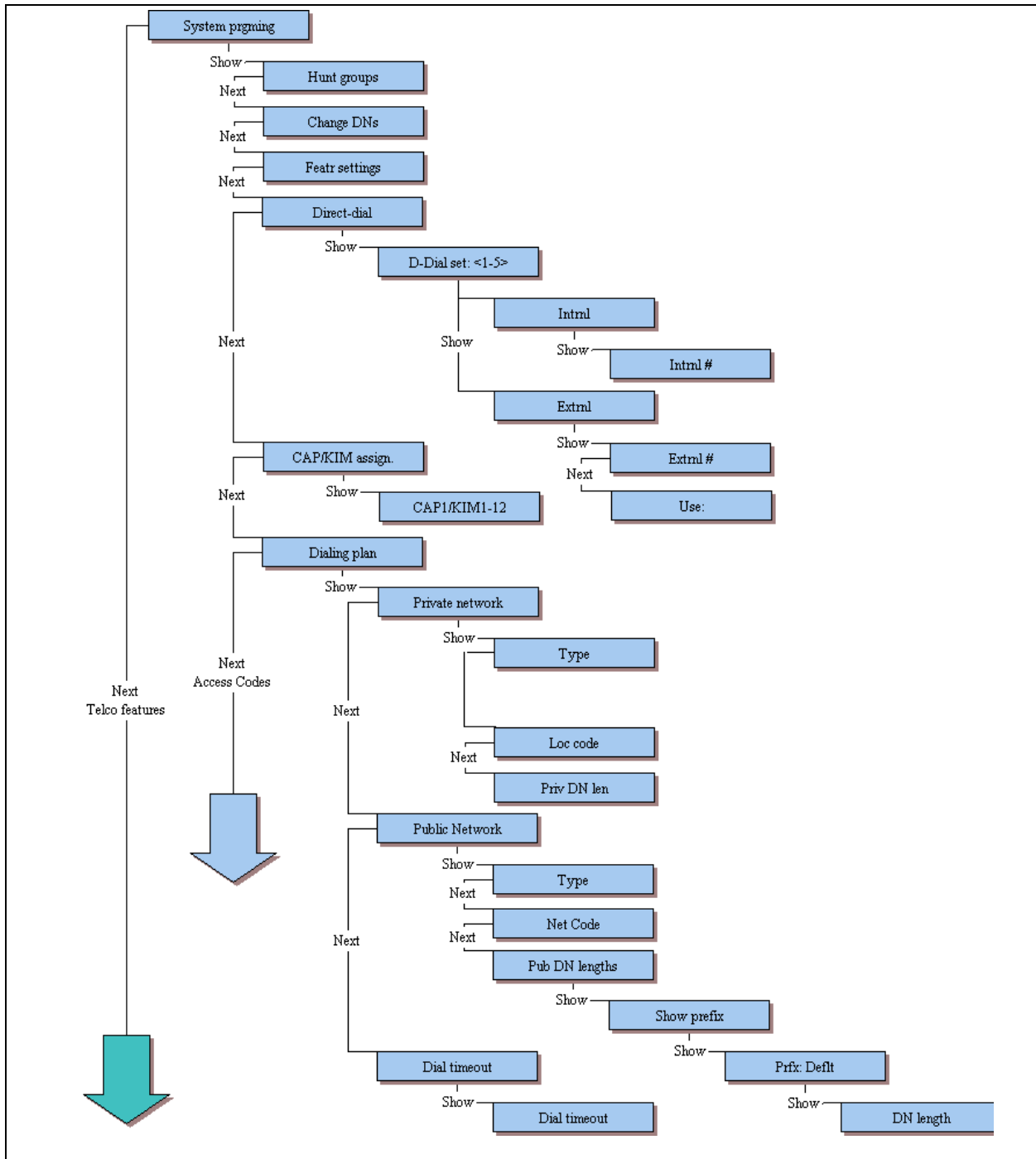
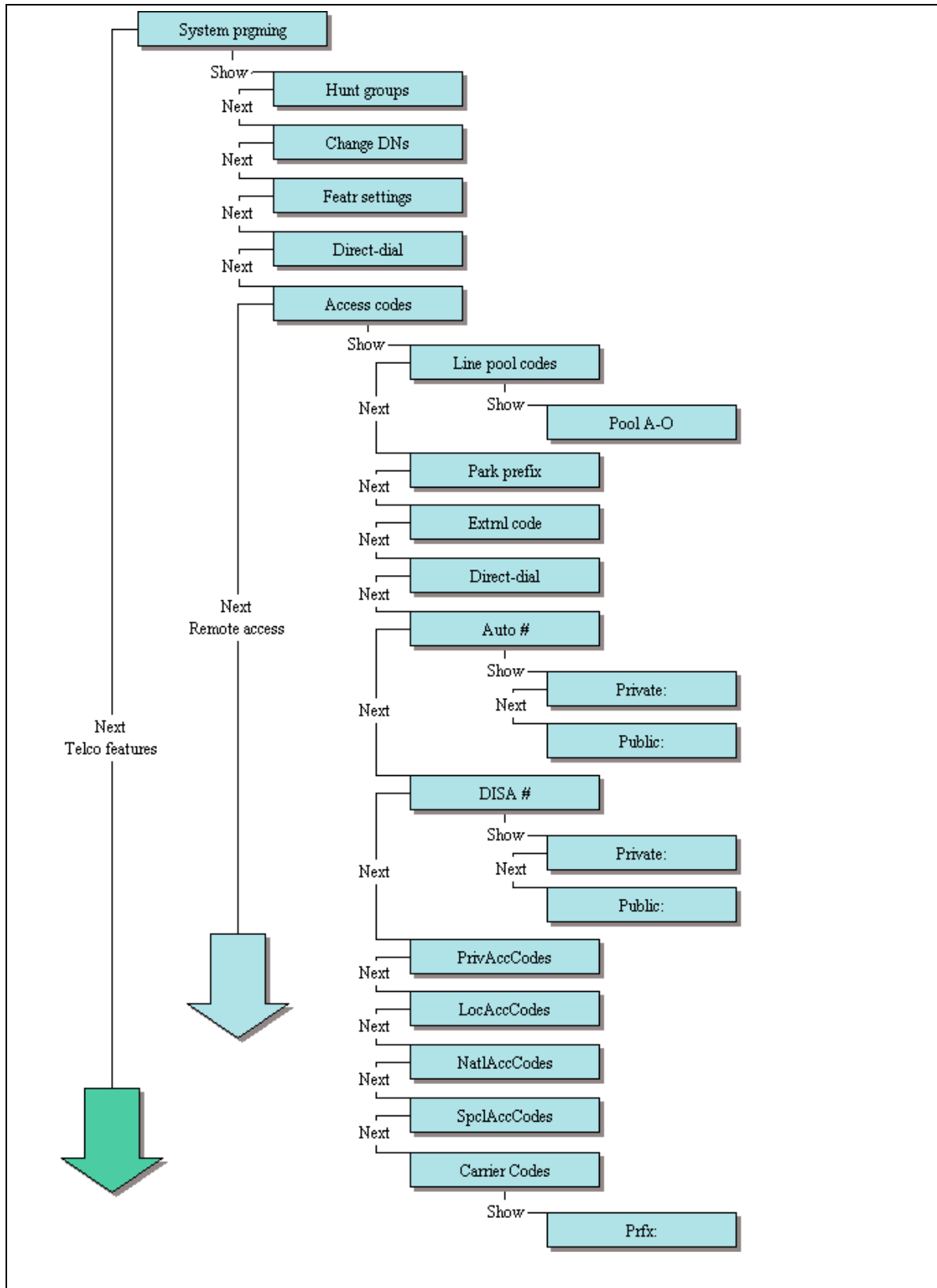

Figure 29 System prgning (Sheet 4 of 7)



**Figure 30** System prgming (page 5 of 7)

Figure 31 System prgming (Sheet 6 of 7)





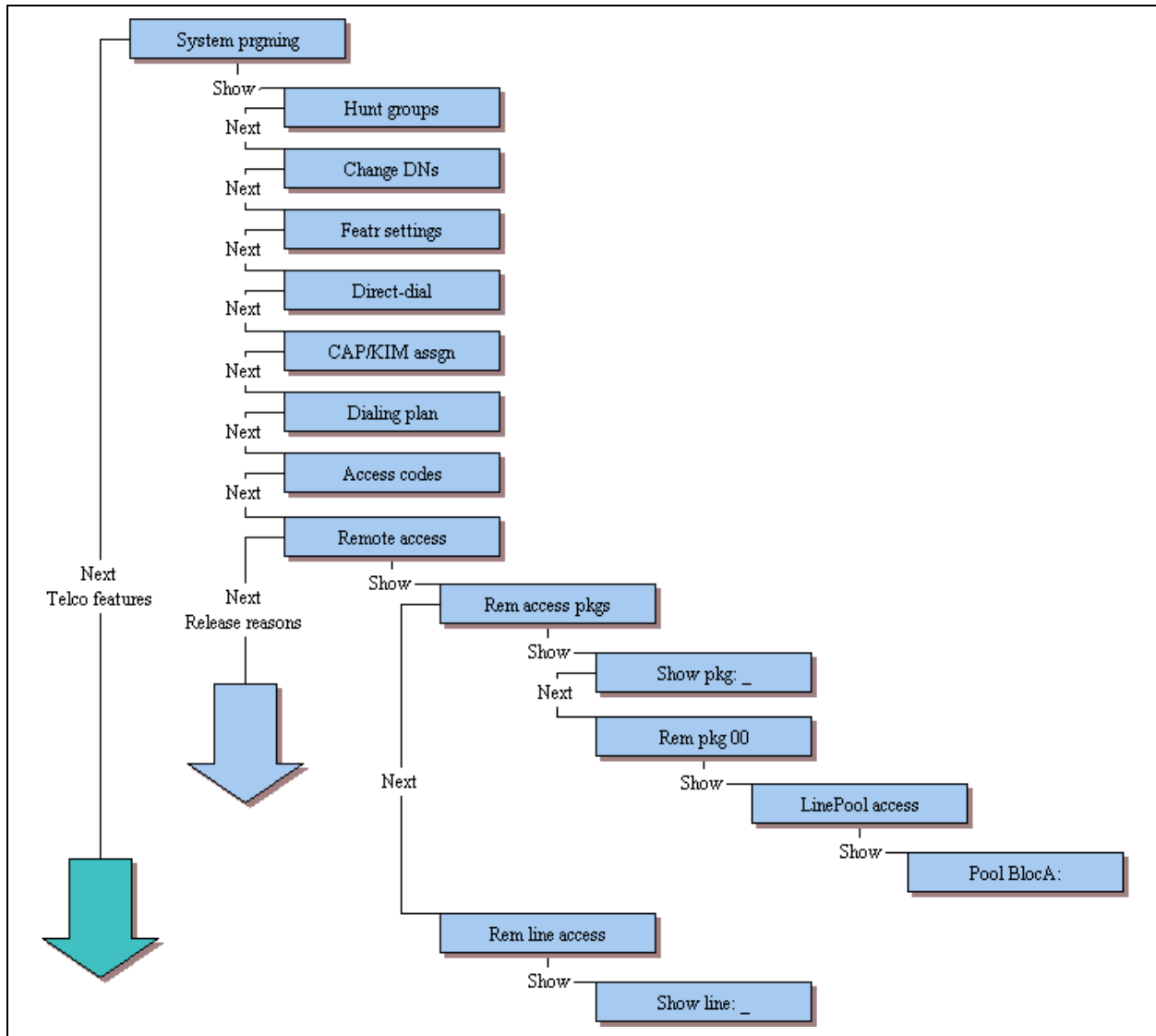
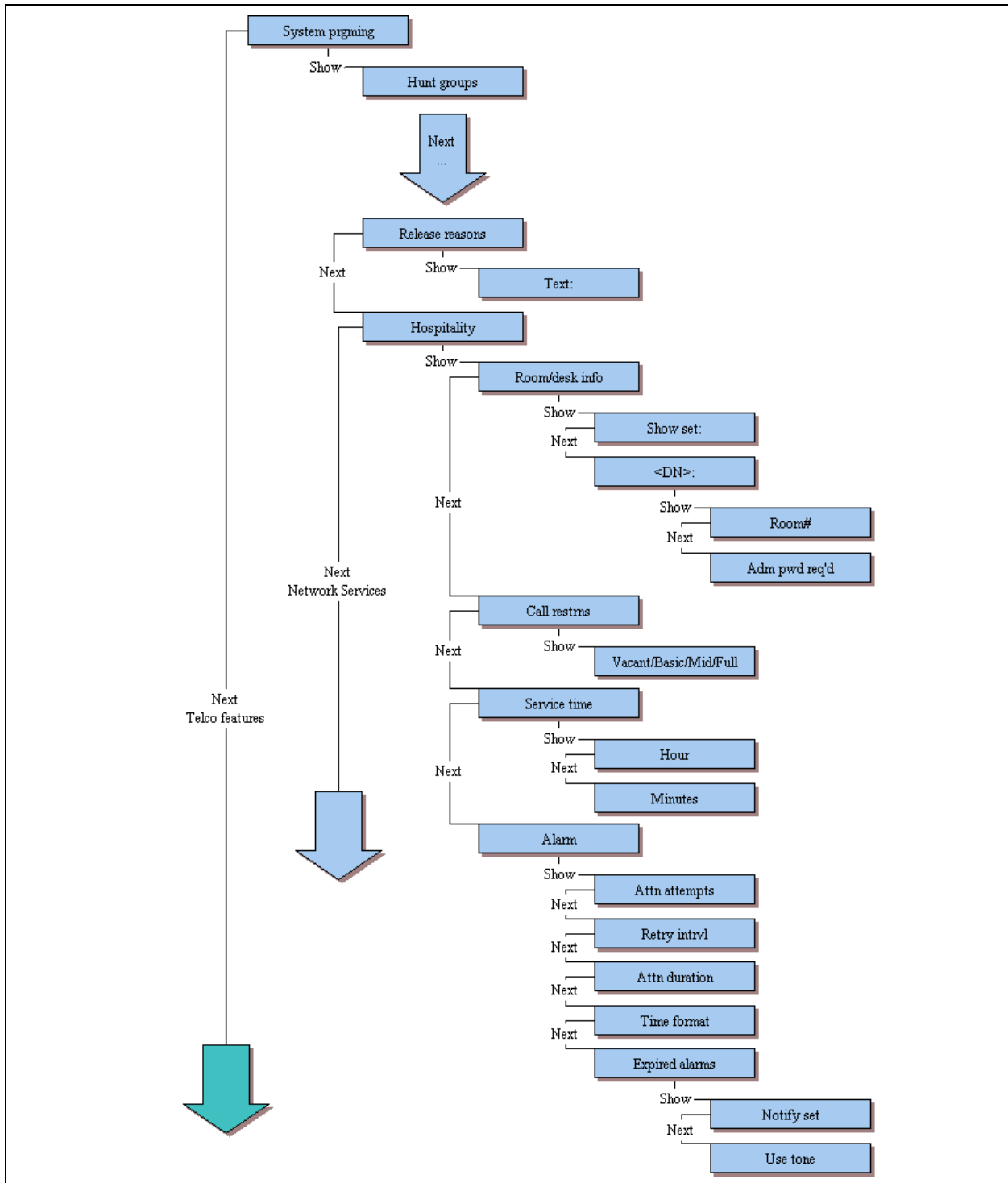

## Telco features

Figure 33 shows the headings under the telset interface **Telco features** heading. These records are used to program external voicemail numbers, and to program the outgoing name and number (ONN) blocking for analog and BRI trunks.

Figure 33 Telco features

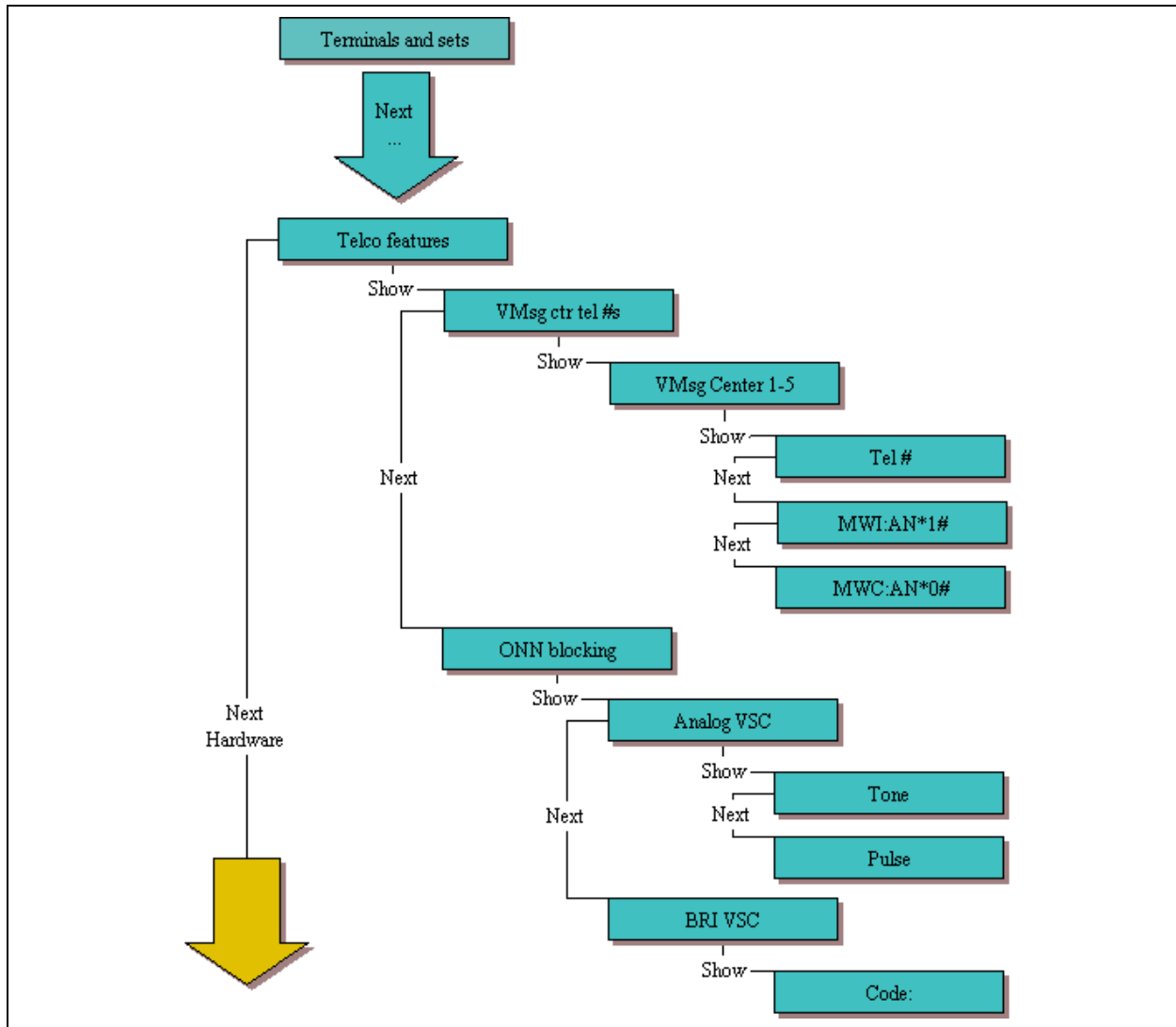

## Hardware

Figure 34 and Figure 35 show the headings under the telset interface **Hardware** heading. These records are used to program the ports on the main unit and any modules connected to the system through the expansion units.

Figure 34 Hardware (Sheet 1 of 2)

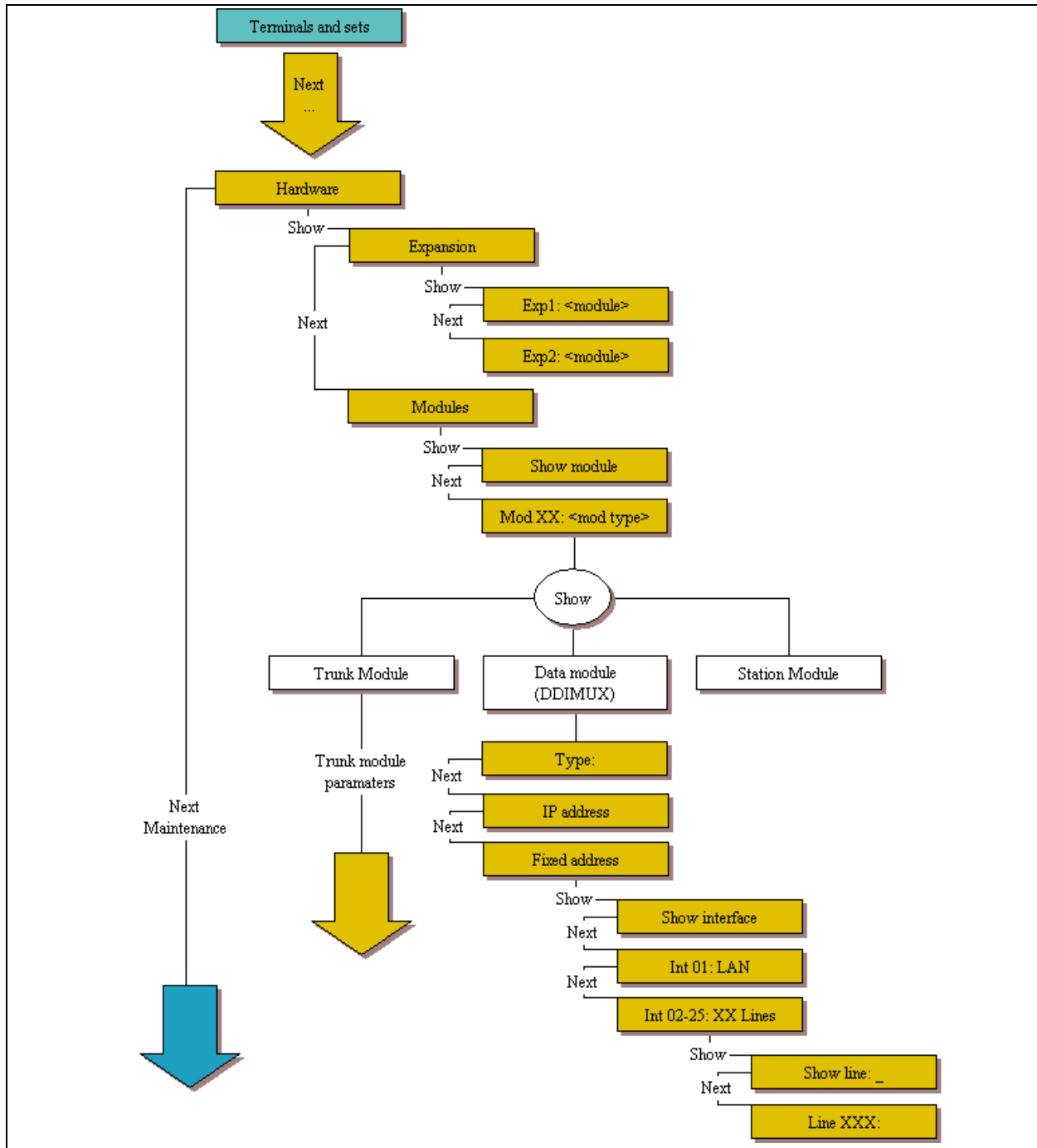
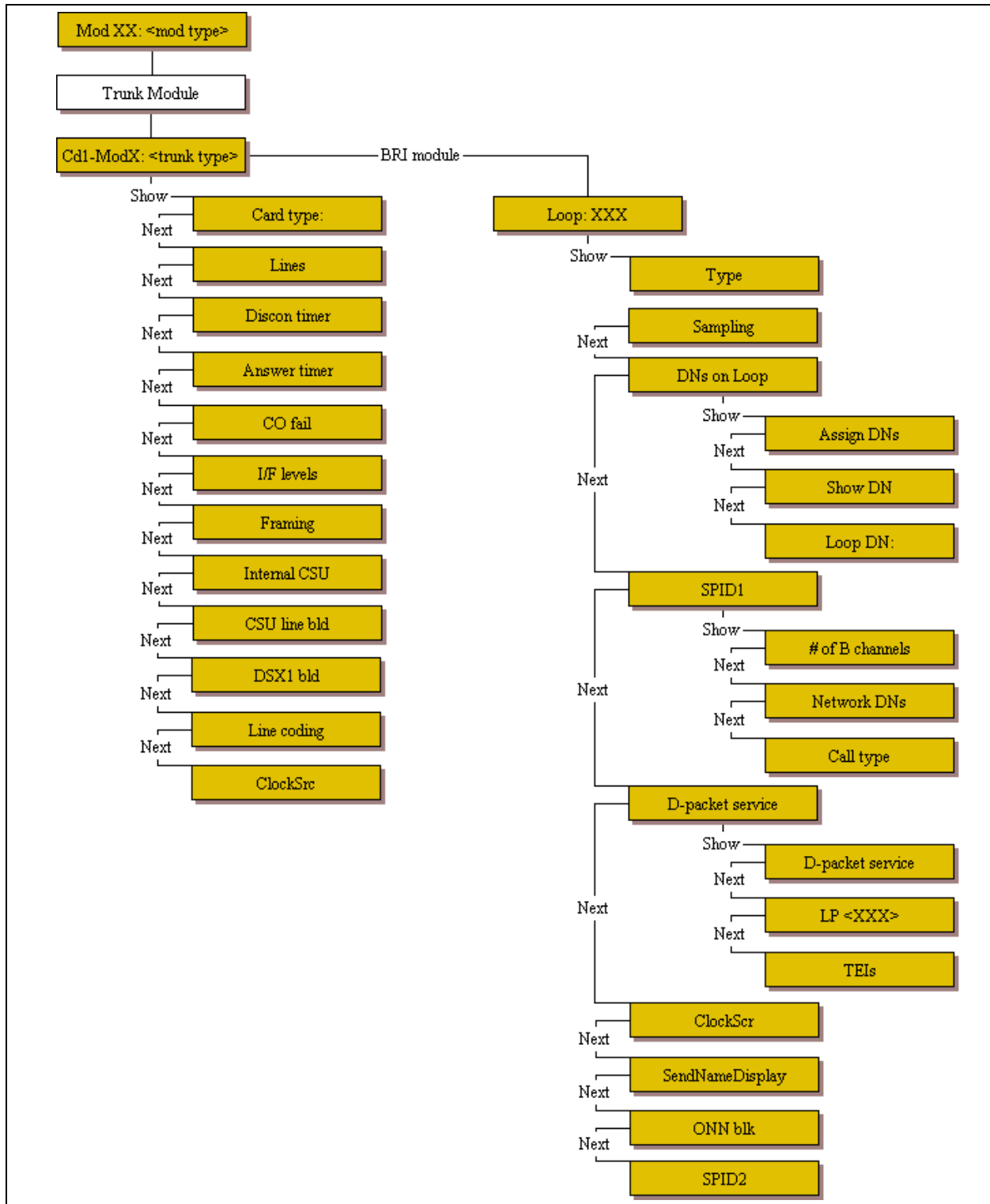

Figure 35 Hardware (page 2 of 2)



## Maintenance

Figure 36 shows the headings under the telset interface **Maintenance** heading. These records are used to test or view statistics about the telephony system.

Figure 36 Maintenance (Sheet 1 of 2)

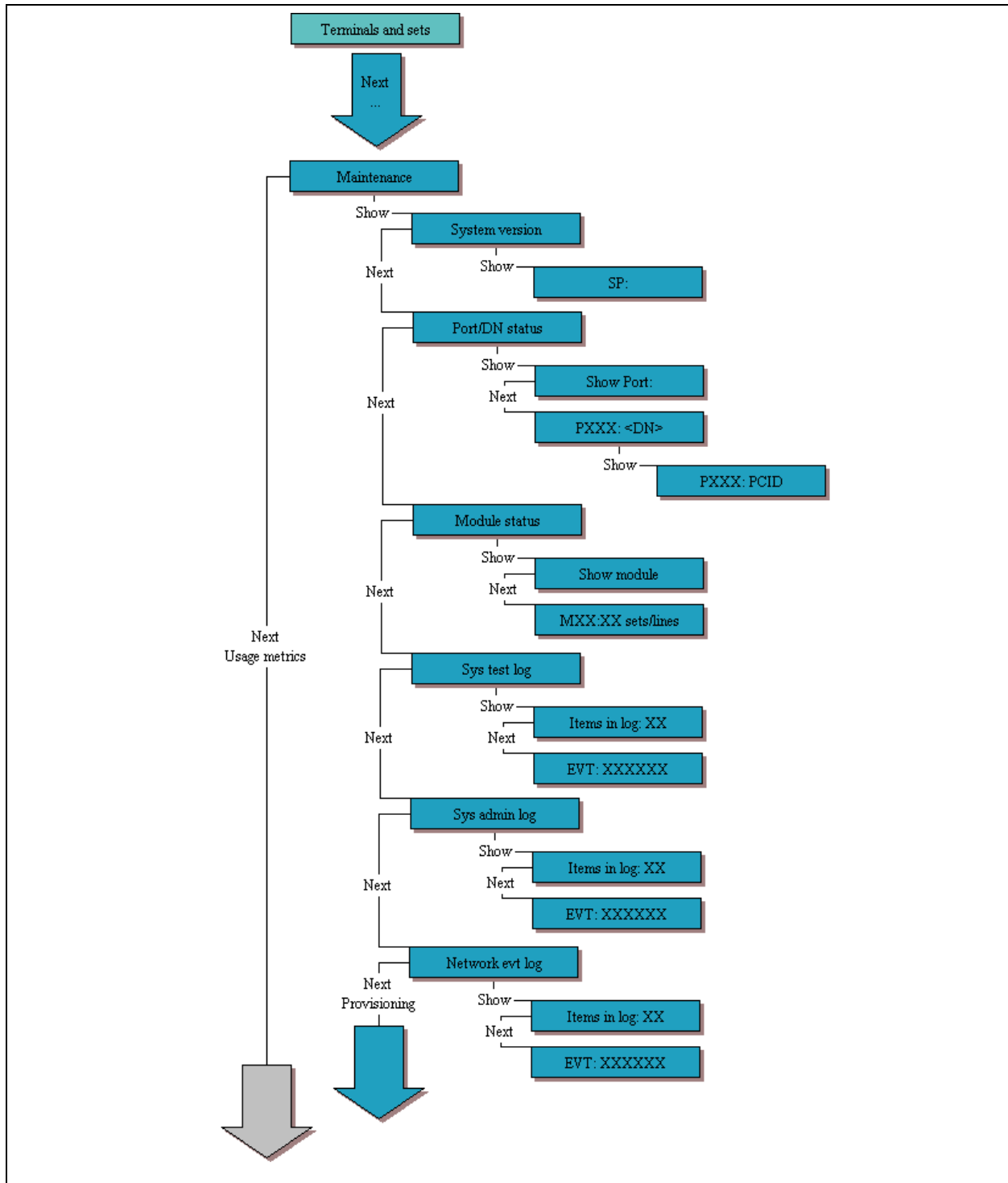
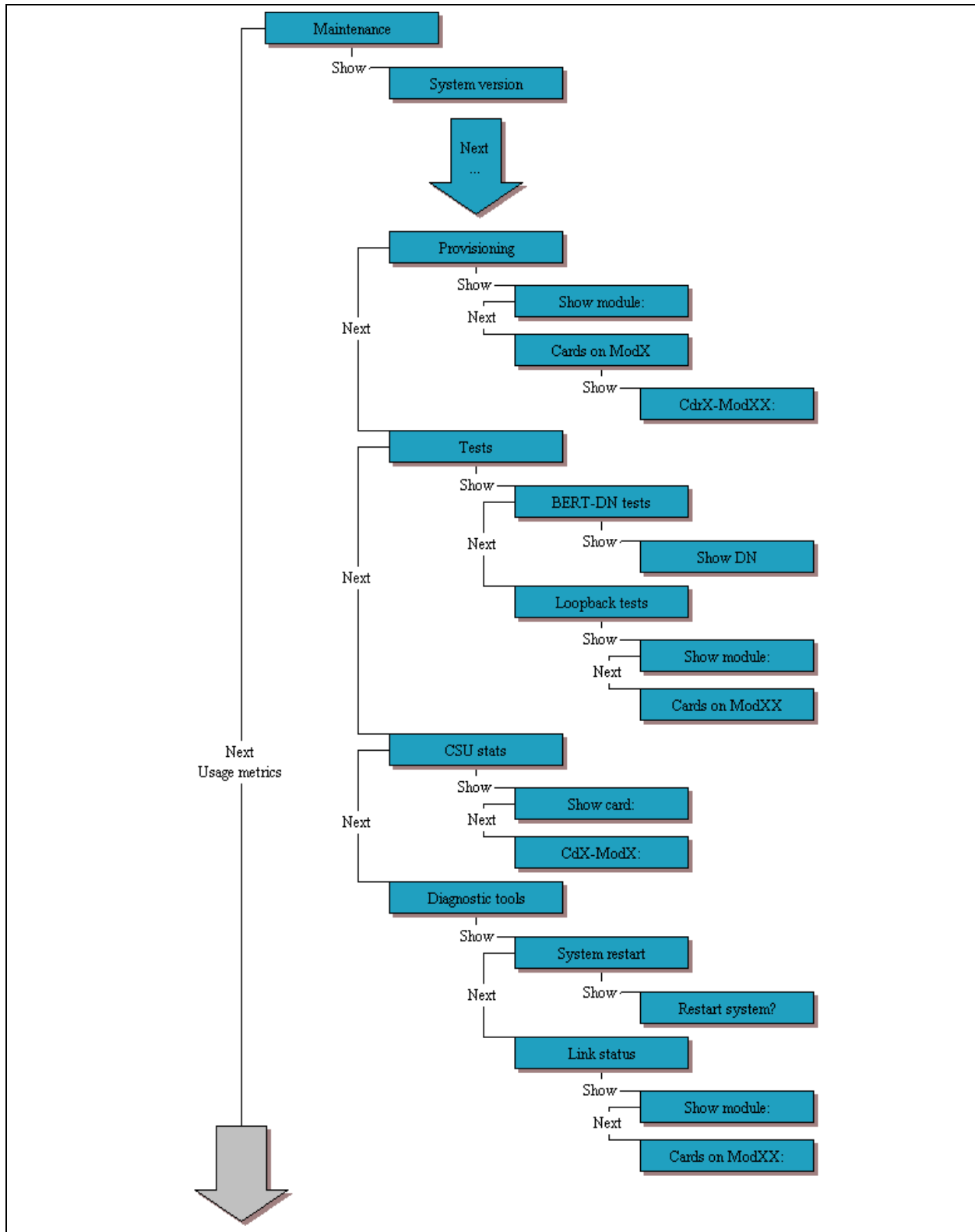

Figure 37 Maintenance (Sheet 2 of 2)



## Usage metrics

Figure 38 shows the headings under the telset interface **Usage Metrics** heading. These records are used to display performance records.

**Figure 38** Usage Metrics

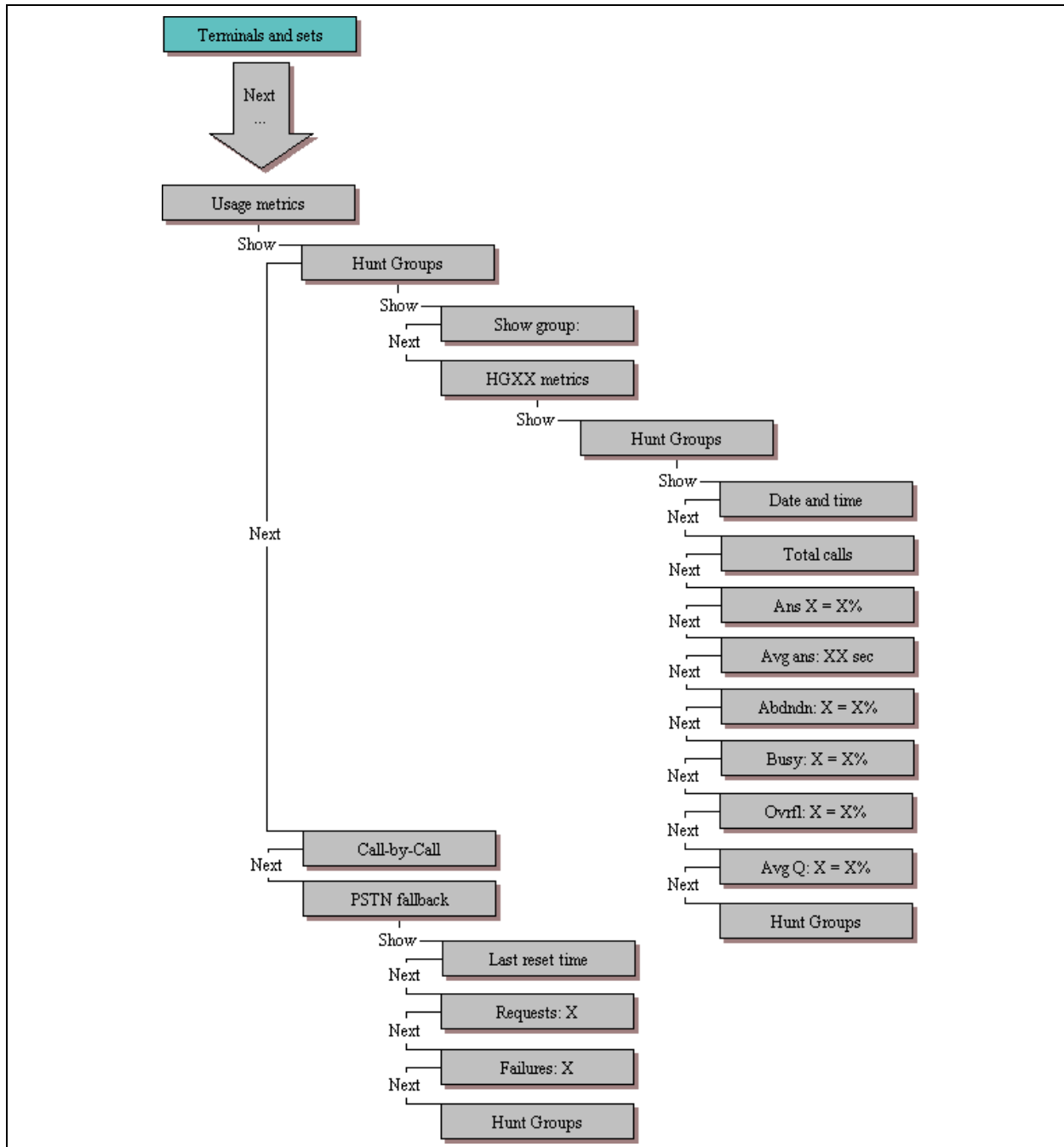





---

# Index

---

## Numerics

7316E  
overlay 24

## C

Conventions, guide 6  
button options 6  
buttons 6  
command line 6  
copyright 2

## D

Display 6

## I

installer programming 21

## O

overlay 23

## P

personal programming 22  
programming  
customizing your system 21  
installer programming 21  
personal programming 22  
programming overlay 23

## R

regulatory information 2  
related publications 8

## S

Symbols 6

## T

trademarks 2

## U

user programming 22

